

ZEMPER

ILUMINACIÓN DE EMERGENCIA

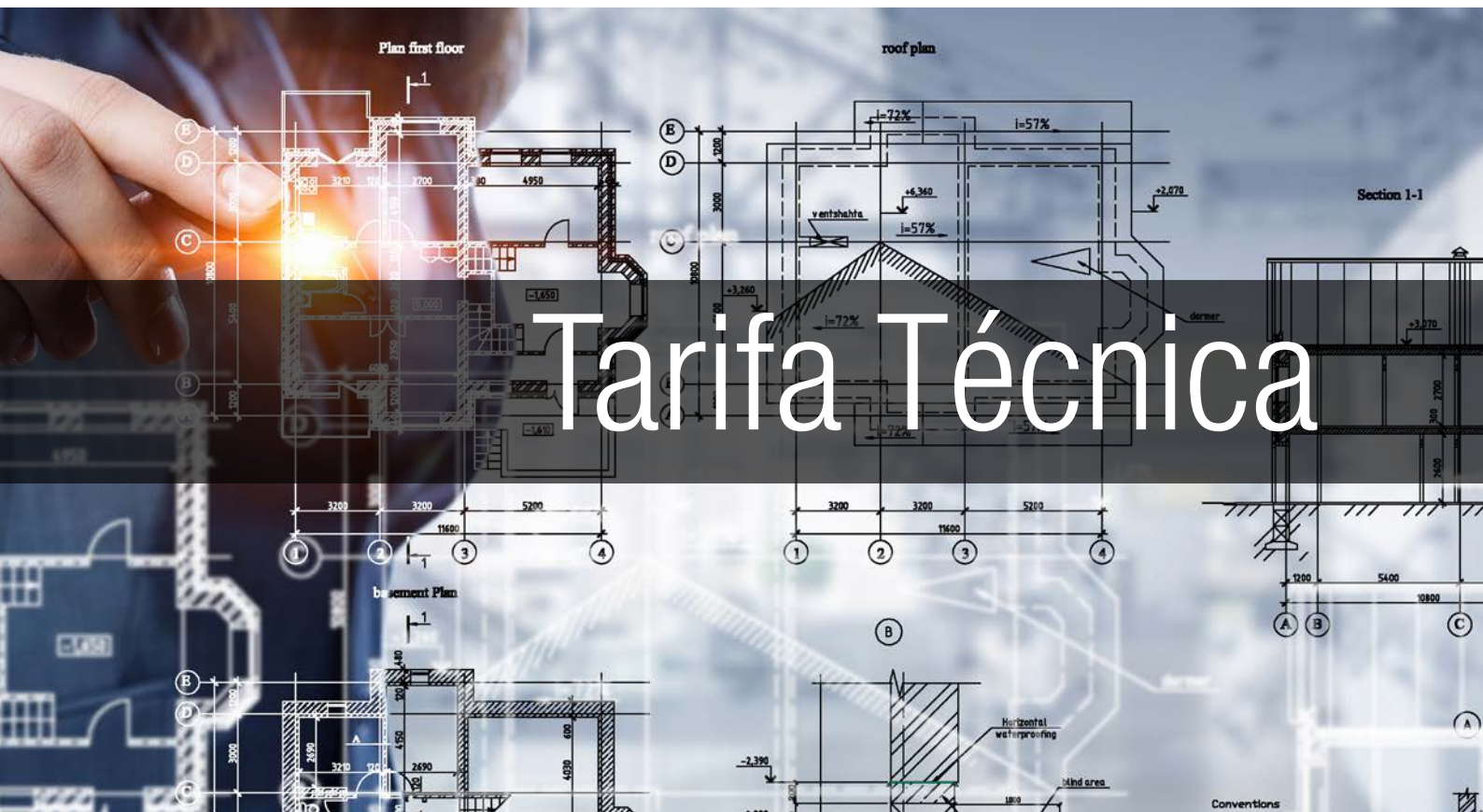

Tarifa Técnica



Índice de Luminarias	4
Premium.....	7
Diseño.....	21
Exit Sign.....	33
Aplicaciones Especiales.....	39
Balizados.....	51
Otros Productos.....	57

ICONOGRAFÍA

IPXX Índice de Protección IP	LED 4000°K Lámpara LED	Ni-Cd Batería de Níquel Cadmio	Conexión Inalámbrica
IKXX Índice de Protección IK	Lm XX XXX Rango Lumínico	Ni-Mh Batería de Níquel Metalhidruro	Autotest
-30° Resistencia a Bajas Temperaturas	XXm. Distancia de Visión	LiFePO ₄ Batería de Litio Hierro Fósforo	Estándar
INOX Construcción en Acero Inoxidable	Fácil Instalación	Pb Batería de Plomo	Respetuosa con el Medio Ambiente
850° Resistente a Hilo Incandescente	Alta Eficiencia Energética	X-Xh. Rango de Duración de Batería	OEM

Certificación IQNet	Certificaciones AENOR	Certificación ENEC	Certificación ATEX	Certificación IECEX
Certificación IECEE	Certificaciones NF	Producto de la CE	Depositar en Punto Limpio	

PREMIUM

DISEÑO

ZEMPER



SPAZIO PLUS
Página 8



SPAZIO LUZ
Página 10



SPAZIO
Página 12



SPAZIO T-LED
Página 14



T-LED
Página 16



DIANA FLAT
Página 22



XENA FLAT
Página 24



VENUS
Página 26



CLASSIC
Página 28

EXIT SIGN

ZEMPER



HARENA
Página 34



KONS
Página 35



LUMINA
Página 36

ESPECIALES Y BALIZADOS

ZEMPER



ARIAN
Página 36



NEPTUNO
Página 38



SATURNO
Página 46



MAXILUM
Página 44



PFL
Página 45



VULCANO
Página 52



VIGIA
Página 53



ORION
Página 54



MINIMINOR
Página 55



TRAZE
Página 56



PREMIUM
ZEMPER

SPAZIO PLUS

SPAZIO PLUS

Todo un proyecto con una misma luminaria

La luminaria se suministra con dos lentes, ambiente y pasillo, fácilmente intercambiables



DIMENSIONES



REFERENCIAS

Lm	Tipo*	Aut. (h)	Batería	Estándar	PVR	Autotest	PVR	Wireless	PVR
100	NP	1	3,6V 0,8A/h Ni-Cd	LSP3105C	45,00€	LSP3105X	55,00€		
200	NP	1	3,6V 1,1A/h Ni-Cd	LSP3205C	50,00€	LSP3205X	65,00€		
100	NP	2	3,6V 0,8A/h Ni-Cd	LSP3105C2	55,00€	LSP3105X2	70,00€		
150	NP	2	3,6V 1,1A/h Ni-Cd	LSP3155C2	60,00€	LSP3155X2	75,00€		
100	P / NP	1	3,2V 0,5A/h LFP			LSP3105LXP	80,00€	LSP3105LDPW	125,00€
250	P / NP	1	3,2V 1,5A/h LFP			LSP3255LXP	85,00€	LSP3255LDPW	135,00€
100	P / NP	2	3,2V 0,8A/h LFP			LSP3105LXP2	90,00€	LSP3105LDP2W	140,00€
200	P / NP	2	3,2V 1,5A/h LFP			LSP3205LXP2	95,00€	LSP3205LDP2W	150,00€

*NP: Entra en emergencia en caso de ausencia de red. *P/NP: Posibilidad de funcionamiento permanente o no permanente mediante tercera borna de selección.



ACCESORIOS



SPAZIO LUZ

SPAZIO LUZ

ZEMPER

Una nueva forma de entender la iluminación de emergencia



DIMENSIONES



REFERENCIAS

Lm	Tipo*	Aut. (h)	Batería	Estándar	PVR	Autotest	PVR	Wireless	PVR
50	NP	1	3,6V 0,3A/h Ni-Cd	LUZ3050C	22,80€	LUZ3050X	30,00€		
100	NP	1	3,6V 0,8A/h Ni-Cd	LUZ3100C	29,00€	LUZ3100X	36,00€		
150	NP	1	3,6V 0,8A/h Ni-Cd	LUZ3150C	34,00€	LUZ3150X	40,00€		
200	NP	1	3,6V 0,8A/h Ni-Cd	LUZ3200C	38,00€	LUZ3200X	45,00€		
300	NP	1	3,6V 1,1A/h Ni-Cd	LUZ3300C	45,70€	LUZ3300X	52,00€		
500	NP	1	2 x 3,2V 1,5A/h LFP	LUZ3500LC	65,50€	LUZ3500LX	71,00€		
150	NP	2	3,6V 1,1A/h Ni-Cd	LUZ3150C2	46,50€	LUZ3150X2	52,00€		
300	NP	2	2 x 3,2V 1,5A/h LFP	LUZ3300LC2	66,50€	LUZ3300LX2	72,50€		
100	P/NP	1	3,2V 0,5A/h LFP	LUZ3100LCP	46,00€	LUZ3100LXP	60,00€	LUZ3100LPW	105,00€
150	P/NP	1	3,2V 0,8A/h LFP	LUZ3150LCP	48,00€	LUZ3150LXP	65,00€	LUZ3150LPW	110,00€
300	P/NP	1	3,2V 1,5A/h LFP	LUZ3300LCP	65,00€	LUZ3300LXP	75,00€	LUZ3300LPW	115,00€
150	P/NP	2	3,2V 1,5A/h LFP			LUZ3150LXP2	70,00€	LUZ3150LDP2W	105,00€
250	P/NP	2	3,2V 1,5A/h LFP			LUZ3250LXP2	85,00€	LUZ3250LDP2W	115,00€

*NP: Entra en emergencia en caso de ausencia de red. *P/NP: Posibilidad de funcionamiento permanente o no permanente mediante tercera borma de selección.

ACCESORIOS



ALQ0011
Marco de empotrar cuadrado
5,00€



ALC0011
Marco de empotrar redondo
5,00€



ALT0011
Conjunto accesorios entrada flexible para tubo superficie
5,00€



ALE0065
Kit Envoltorio IP65 CIRCULAR
15,50€



ALX0011
Señalización con marco empotrar cuadrado
25,00€

SPAZIO

Una de las luminarias más eficientes en consumo y prestaciones de Zemper

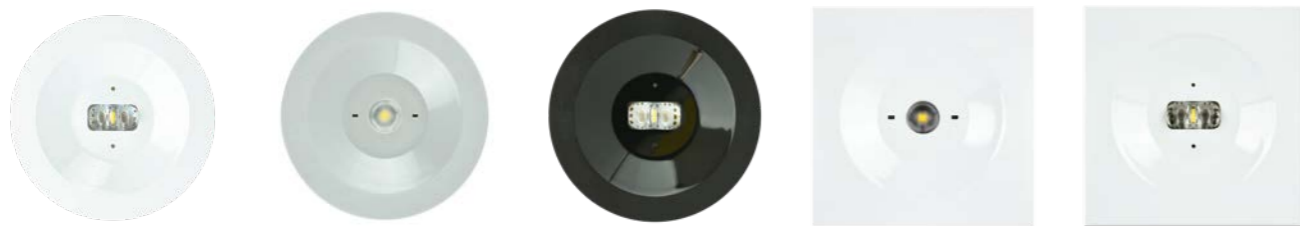

DIMENSIONES

Spazio LSR

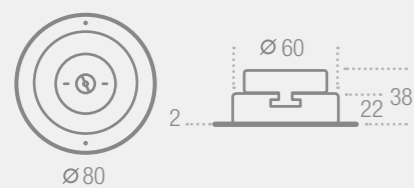

Spazio LSQ

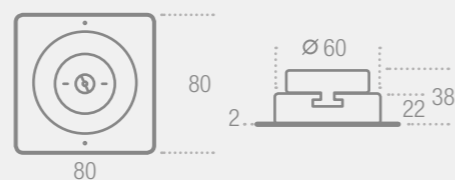

SPAZIO

ZEMPER

REFERENCIAS

SPAZIO Q - Cuadrada

lm	Tipo*	Aut. (h)	Batería	Dali	PVR	Autotest	PVR	Wireless	PVR
250	P/NP	1	3,2V 1,5A/h LFP			LSQ3250LXP	95,49€	LSQ3250LDPW	125,49€
250	P/NP	1	3,2V 1,5A/h LFP			LSQ3251LXP	95,49€	LSQ3251LDPW	125,49€
200	P/NP	2	3,2V 1,5A/h LFP			LSQ3200LXP2	100,49€	LSQ3200LDP2W	130,49€
200	P/NP	2	3,2V 1,5A/h LFP			LSQ3201LXP2	100,49€	LSQ3201LDP2W	130,49€
200	P/NP	1	3,2V 1,5A/h LFP	LSQ3180LAP	125,49€				
200	P/NP	1	3,2V 1,5A/h LFP	LSQ3181LAP	125,49€				

SPAZIO R - Redonda

lm	Tipo*	Aut. (h)	Batería	Dali	PVR	Autotest	PVR	Wireless	PVR
250	P/NP	1	3,2V 1,5A/h LFP			LSR3250LXP	95,49€	LSR3250LDPW	125,49€
250	P/NP	1	3,2V 1,5A/h LFP			LSR3251LXP	95,49€	LSR3251LDPW	125,49€
200	P/NP	2	3,2V 1,5A/h LFP			LSR3200LXP2	100,49€	LSR3200LDP2W	130,49€
200	P/NP	2	3,2V 1,5A/h LFP			LSR3201LXP2	100,49€	LSR3201LDP2W	130,49€
200	P/NP	1	3,2V 1,5A/h LFP	LSR3180LAP	125,49€				
200	P/NP	1	3,2V 1,5A/h LFP	LSR3181LAP	125,49€				

*P/NP: Posibilidad de funcionamiento permanente o no permanente mediante tercera borna de selección.
Referencias LSQ***OL*** y LSR***OL*** disponen de lente ambiente. Referencias LSQ***1L*** y LSR***1L*** disponen de lente pasillo.

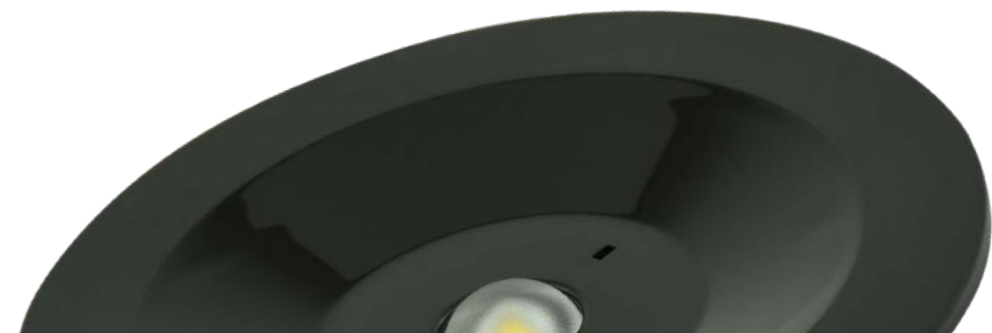

ACCESORIOS



SPAZIO T·LED·

Una de las luminarias más eficientes en consumo y prestaciones de Zemper



Lente ambiente

Lente pasillo

Lente pasillo (cruce techo)

Lente pared

DIMENSIONES



SPAZIO T·LED·

ZEMPER

REFERENCIAS

Im	Tipo*	Aut. (h)	Batería	Autotest	PVR	Wireless	PVR
520	P/NP	1	3,2V 3,0A/h LFP	LST3500LXP	94,56€	LST3500LDPW	145,56€
520	P/NP	1	3,2V 3,0A/h LFP	LST3501LXP	94,56€	LST3501LDPW	145,56€
520	P/NP	1	3,2V 3,0A/h LFP	LST3502LXP	94,56€	LST3502LDPW	145,56€
400	P/NP	2	3,2V 3,0A/h LFP	LST3400LXP2	94,56€	LST3400LDP2W	145,56€
400	P/NP	2	3,2V 3,0A/h LFP	LST3401LXP2	94,56€	LST3401LDP2W	145,56€
400	P/NP	2	3,2V 3,0A/h LFP	LST3402LXP2	94,56€	LST3402LDP2W	145,56€

*P/NP: Posibilidad de funcionamiento permanente o no permanente mediante tercera borna de selección.

Referencias LST***OL*** disponen de lente ambiente. Referencias LST***L*** disponen de lente pasillo. Referencias LST***2L*** disponen de lente pared.
Para solicitar luminaria con "lente pasillo cruce techo" consulte con nuestro Dpto. Comercial.



ACCESORIOS



ABT(XX)081
Soporte superficie con
banderola serigrafiada
32,20€



ABX(XX)61
Accesorio empotrar techo blanco
+ banderola serigrafiada
29,95€



AMT0061
Accesorio empotrar
techo blanco
5,40€

Luminaria arquitectural de gran eficiencia energética



DIMENSIONES



REFERENCIAS IP 42

Lm	Tipo*	Aut. (h)	Batería	Autotest	PVR	Wireless	PVR
50	NP	1	3,6V 0,3A/h Ni-Cd	LTS3050X	49,21€		
120	P/NP	1	3,6V 0,8A/h Ni-Cd	LTS3150X	52,18€		
250	P/NP	1	3,6V 1,6A/h Ni-Cd	LTS3200X	57,71€		
320	P/NP	1	4,8V 1,6A/h Ni-Cd	LTS3300X	72,36€		
400	P/NP	1	6V 1,6A/h Ni-Cd	LTS3400X	75,39€		
150	P/NP	2	4,8V 1,6A/h Ni-Cd	LTS3150X2	73,06€		
300	P/NP	2	6V 1,6A/h Ni-Cd	LTS3300X2	76,89€		
100	P/NP	1	3,2V 0,5A/h LFP	LTS3100LXP	66,58€	LTS3100DPW	115,58€
250	P/NP	1	3,2V 1,5A/h LFP	LTS3250LXP	70,06€	LTS3250DPW	120,56€
400	P/NP	1	6,4V 1,5A/h LFP	LTS3400LXP	87,89€	LTS3400DPW	136,89€
150	P/NP	2	3,2V 1,5A/h LFP	LTS3150LXP2	70,56€	LTS3150DP2W	121,56€
300	P/NP	2	3,2V 3,0A/h LFP	LTS3300LXP2	88,89€	LTS3300DP2W	137,89€

REFERENCIAS IP 65

Lm	Tipo*	Aut. (h)	Batería	Autotest	PVR	Wireless	PVR
50	NP	1	3,6V 0,3A/h Ni-Cd	LTE3050X	51,56		
120	P/NP	1	3,6V 0,8A/h Ni-Cd	LTE3150X	54,56		
250	P/NP	1	3,6V 1,6A/h Ni-Cd	LTE3200X	60,56		
320	P/NP	1	4,8V 1,6A/h Ni-Cd	LTE3300X	75,06		
400	P/NP	1	6V 1,6A/h Ni-Cd	LTE3400X	77,89		
150	P/NP	2	4,8V 1,6A/h Ni-Cd	LTE3150X2	75,56		
300	P/NP	2	6V 1,6A/h Ni-Cd	LTE3300X2	79,39		
100	P/NP	1	3,2V 0,5A/h LFP	LTE3100LXP	69,08	LTE3100DPW	118,08
250	P/NP	1	3,2V 1,5A/h LFP	LTE3250LXP	72,56	LTE3250DPW	123,06
400	P/NP	1	6,4V 1,5A/h LFP	LTE3400LXP	90,89	LTE3400DPW	139,39
150	P/NP	2	3,2V 1,5A/h LFP	LTE3150LXP2	73,06	LTE3150DP2W	124,06
300	P/NP	2	3,2V 3,0A/h LFP	LTE3300LXP2	91,39	LTE3300DP2W	140,89

*NP: Entra en emergencia en caso de ausencia de red.

*P/NP: Posibilidad de funcionamiento permanente o no permanente mediante tercera borna de selección.



T·LED·

ZEMPER



ACCESORIOS



IP42: ABT(XX)081 / IP65: ABT(XX)91
Soporte superficie con banderola serigrafiada
32,20€



IP42: ABX(XX)81 / IP65: ABX(XX)91
Marco empotrar techo con banderola serigrafiada
29,95€



IP42: AET0081
Caja metálica empotrar*
muro/pared
26,90€



Ref IP65: AGT000
Rejilla de protección
23,75€

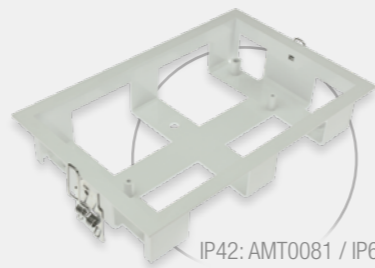

IP42: AMT0081 / IP65: AMT0091
Accesorio empotrar techo blanco
5,40€



APT3(XX)
Pictograma señalización
3,00€



CTLD005
Difusor transparente alto rendimiento (+20% flujo lum.)
2,10€

*Para opción de empotrar en pared es necesario pedir AET0081 + AMT00(X)1





DISEÑO
ZEMPER

DIANA FLAT

DIANA FLAT

ZEMPER

Nueva luminaria extraplana fácilmente integrable



DIMENSIONES

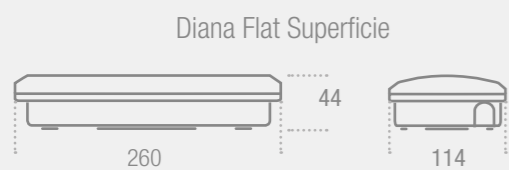

REFERENCIAS

lm	Tipo*	Aut. (h)	Batería	Estándar	PVR	Autotest	PVR
50	NP	1	3,6V 0,3A/h Ni-Cd	LDF3050C	28,34€	LDF9050X	36,34€
70	NP	1	3,6V 0,3A/h Ni-Cd	LDF3070C	31,74€	LDF9070X	38,34€
100	NP	1	3,6V 0,3A/h Ni-Cd	LDF3100C	35,96€	LDF9100X	43,46€
150	NP	1	3,6V 0,8A/h Ni-Cd	LDF3150C	41,86€	LDF9150X	48,46€
200	NP	1	3,6V 0,8A/h Ni-Cd	LDF3200C	45,86€		
200	NP	1	3,6V 1,6A/h Ni-Cd			LDF9200X	54,46€
315	NP	1	3,6V 1,6A/h Ni-Cd	LDF3300C	55,96€	LDF9300X	62,46€
400	NP	1	3,6V 1,6A/h Ni-Cd	LDF3400C	69,46€		
400	NP	1	4,8V 1,6A/h Ni-Cd			LDF9400X	77,46€
500	NP	1	6V 1,6A/h Ni-Cd	LDF3500C	80,03€	LDF9500X	84,03€
100	P/NP	1	3,6V 0,8A/h Ni-Cd	LDF9100CP	60,56€		
150	P/NP	1	3,6V 0,8A/h Ni-Cd	LDF9150CP	61,46€		
225	P/NP	1	3,6V 1,6A/h Ni-Cd	LDF9200CP	66,96€		
315	P/NP	1	3,6V 1,6A/h Ni-Cd	LDF9300CP	82,96€		
150	P/NP	2	3,6V 1,6A/h Ni-Cd	LDF9150CP2	68,96€		
100	P/NP	1	3,2V 0,8A/h LFP			LDF9100LXP	70,50€
150	P/NP	1	3,2V 0,8A/h LFP			LDF9150LXP	71,90€
225	P/NP	1	3,2V 1,5A/h LFP			LDF9200LXP	77,34€
315	P/NP	1	3,2V 1,5A/h LFP			LDF9300LXP	90,84€
150	P/NP	2	3,2V 1,5A/h LFP			LDF9150LXP2	77,34€
325	P/NP	2	3,2V 3,0A/h LFP			LDF9300LXP2	110,96€

*NP: funciona solo en caso de ausencia de red.

*P/NP: Posibilidad de funcionamiento permanente o no permanente mediante jumper.

ACCESORIOS

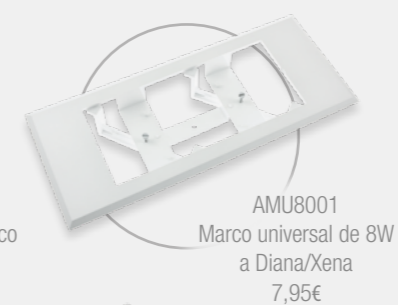

XENA FLAT

El modelo Xena en formato extraplano

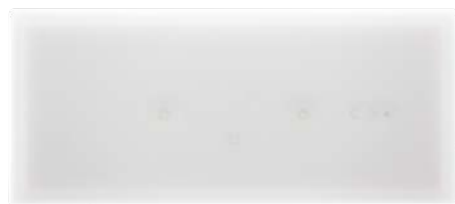

DIMENSIONES

Xena Flat Superficie

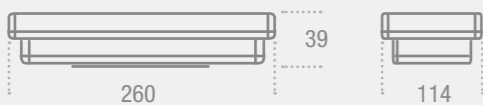

Xena Flat Encastrado



XENA FLAT

ZEMPER

REFERENCIAS

Im	Tipo*	Aut. (h)	Batería	Estándar	PVR	Autotest	PVR	Wireless	PVR
75	NP	1	3,6V 0,3A/h Ni-Cd	LXF9070C	22,99€				
100	NP	1	3,6V 0,8A/h Ni-Cd	LXF9100C	27,06€				
150	NP	1	3,6V 0,8A/h Ni-Cd	LXF9150C	32,06€				
200	NP	1	3,6V 1,6A/h Ni-Cd	LXF9200C	38,06€				
315	NP	1	3,6V 1,6A/h Ni-Cd	LXF9300C	48,56€				
400	NP	1	6V 1,6A/h Ni-Cd	LXF9400C	54,39€				
100	P/NP	1	3,6V 0,8A/h Ni-Cd	LXF9100CP	42,06€				
150	P/NP	1	3,6V 0,8A/h Ni-Cd	LXF9150CP	44,06€				
200	P/NP	1	3,6V 1,6A/h Ni-Cd	LXF9200CP	47,56€				
315	P/NP	1	3,6V 1,6A/h Ni-Cd	LXF9300CP	59,06€				
125	P/NP	2	3,6V 1,6A/h Ni-Cd	LXF9150CP2	48,06€				
100	P/NP	1	3,2V 0,8A/h LFP			LXF9100LXP	52,08€	LXF9100LDPW	90,58€
150	P/NP	1	3,2V 0,8A/h LFP			LXF9150LXP	55,08€	LXF9150LDPW	92,58€
200	P/NP	1	3,2V 1,5A/h LFP			LXF9200LXP	57,49€	LXF9200LDPW	97,49€
315	P/NP	1	3,2V 1,5A/h LFP			LXF9300LXP	71,99€	LXF9300LDPW	105,99€
125	P/NP	2	3,2V 1,5A/h LFP			LXF9150LXP2	59,99€	LXF9150LDP2W	92,49€

DALI

Im	Tipo*	Aut. (h)	Batería	DALI	PVR
300	P/NP	1	3,2V 1,5A/h LFP	LXF9300LAP	105,99€

*NP: funciona solo en caso de ausencia de red.

*P/NP: Posibilidad de funcionamiento permanente o no permanente mediante jumper.

ACCESORIOS



ABX4071
Conjunto marco empotrar
+ banderola X6
25,00€



AED0071
Conjunto accesorios
semiempotrar pared blanco
6,39€



AMD0041
Conjunto accesorios
empotrar techo blanco
5,40€



APV6(XX)
Pictograma señalización
1,60€

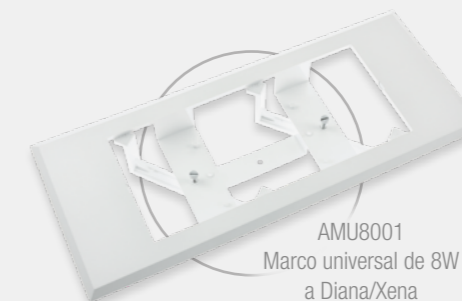

AMU8001
Marco universal de 8W
a Diana/Xena
7,95€



CDX008
Difusor transparente
(+20% flujo lum.)
0,70€

VENUS

IK07 para una luminaria estanca de gran funcionalidad



DIMENSIONES

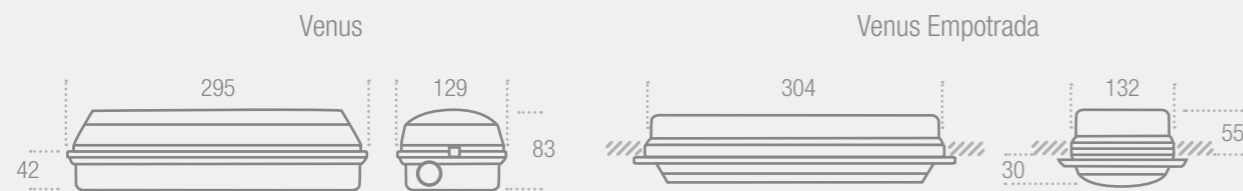

VENUS

ZEMPER

REFERENCIAS

Im	Tipo*	Aut. (h)	Batería	Estándar	PVR	Autotest	PVR	Wireless	PVR
100	P/NP	1	3,6V 0,8A/h Ni-Cd	LVE9100CP	41,06€				
150	P/NP	1	3,6V 0,8A/h Ni-Cd	LVE9150CP	42,06€				
315	P/NP	1	3,6V 1,6A/h Ni-Cd	LVE9300CP	55,56€				
150	P/NP	2	3,6V 1,6A/h Ni-Cd	LVE9150CP2	47,56€				
325	P/NP	2	3,6V 2,0A/h Ni-Cd	LVE9300CP2	75,56€				
100	P/NP	1	3,2V 0,8A/h LFP			LVE9100LXP	51,08€	LVE9100LDPW	92,08€
150	P/NP	1	3,2V 0,8A/h LFP			LVE9150LXP	52,58€	LVE9150LDPW	97,48€
315	P/NP	1	3,2V 1,5A/h LFP			LVE9300LXP	64,99€	LVE9300LDPW	105,49€
500	P/NP	1	6,4V 1,5A/h LFP			LVE9500LXP	75,56€	LVE9500LDPW	118,56€
150	P/NP	2	3,2V 1,5A/h LFP			LVE9150LXP2	56,39€	LVE9150LDP2W	95,49€
325	P/NP	2	3,2V 3,0A/h LFP			LVE9300LXP2	83,46€	LVE9300LDP2W	120,56€

*P/NP: Posibilidad de funcionamiento permanente o no permanente mediante tercera borna de selección.



ACCESORIOS

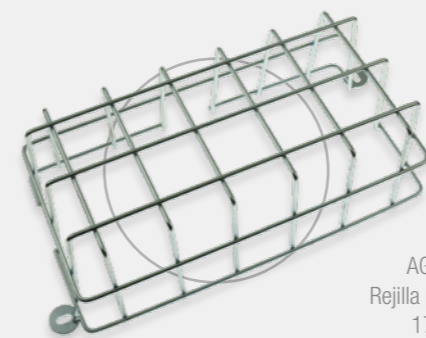

AGV120
Rejilla protección
17,31€



ATE87101
Conjunto accesorios
empotrar techo blanco
5,40€



APV6(XX)
Pictograma
señalización
1,60€

CLASSIC

Luminaria redonda multifuncional



CLASSIC
ZEMPER



REFERENCIAS

lm	Tipo*	Aut. (h)	Batería	Estándar	PVR
110	P/NP	3	3,6V 1,6A/h NiMH	LCS3110ECC3	115,56€

*P/NP: Posibilidad de funcionamiento permanente o no permanente mediante tercera borna de selección.

lm	Tipo	Lamp (W)	Luminaria	PVR
1200	230Vac	LED	LCS312223	90,45€

DIMENSIONES

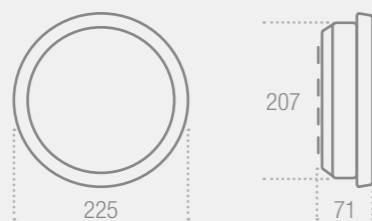

ACCESORIOS



APE22201
Conjunto
accesorios
enrasar pared
blanco
8,80€



ATE22201
Conjunto
accesorios
enrasar techo
blanco
7,25€





EXIT SIGN

ZEMPER

HARENA

Versatilidad en dos versiones: exit sign y emergencia con dos LEDs

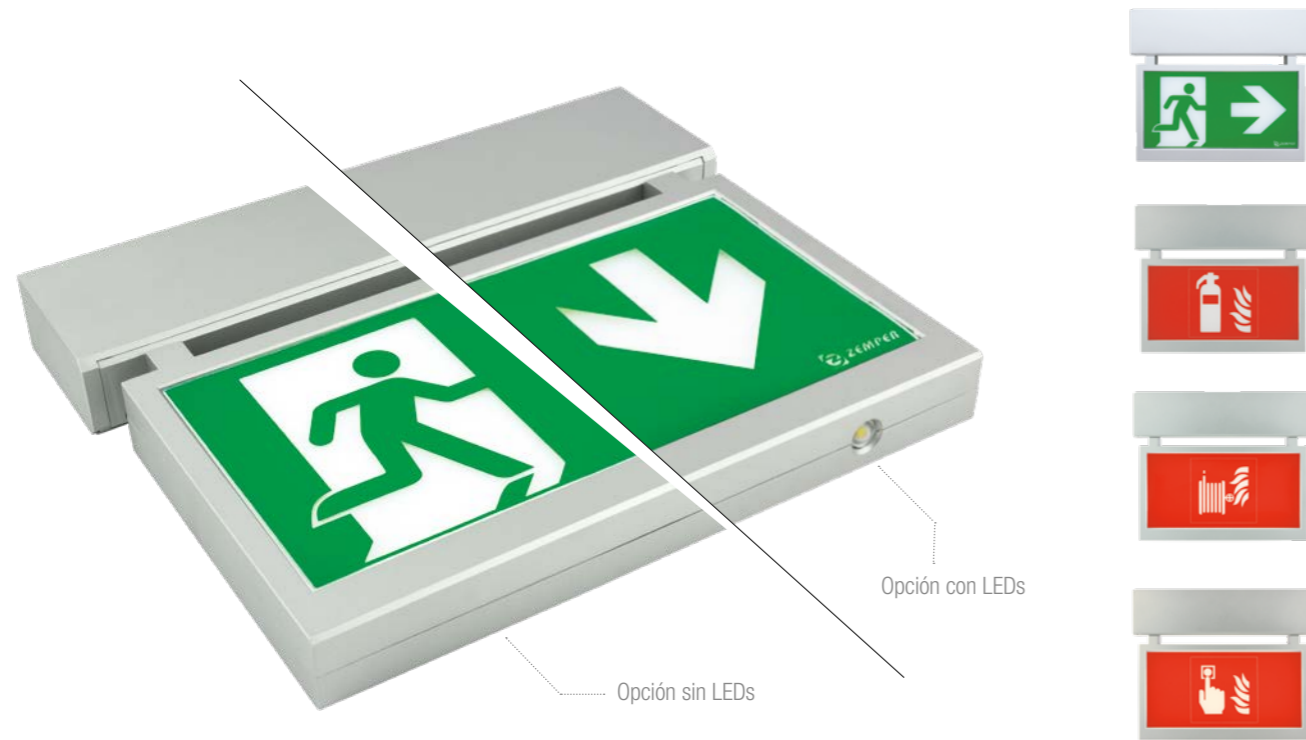

REFERENCIAS

Im	Tipo*	Aut. (h)	Batería	Autotest	PVR
120	P	1	3,2V 3A/h LFP	LHS3120LXP	178,56€
-	P	1	3,2V 1,5A/h LFP	LHS3070LXP	92,49€

*P: funcionamiento permanente.

Se suministra con un juego completo de pictogramas



DIMENSIONES

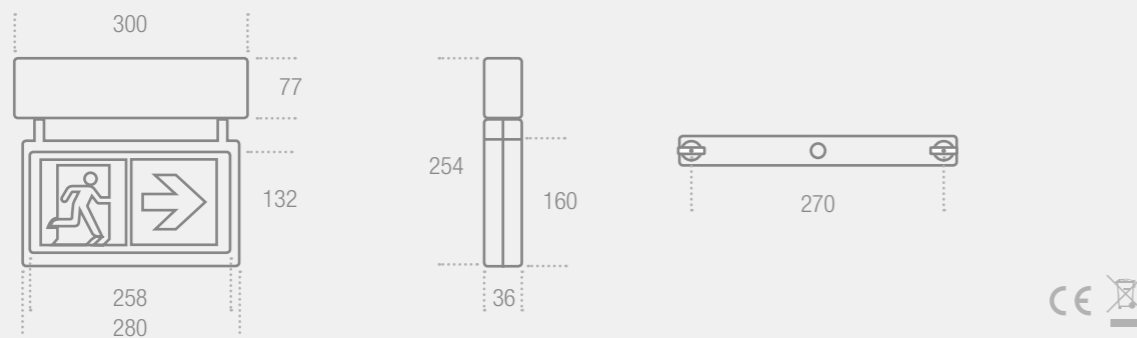

KONS

Uniendo funcionalidad, estética y economía



REFERENCIAS

Lamp.	Tipo*	Aut. (h)	Batería	Estándar	PVR	DALI	PVR
LED	P	1	3,6V 1,6A/h Ni-Cd	LKS3070CP	72,56€		
LED	P	1	3,2V 1,5A/h LFP			LKS3070LAP	72,49€

*P: funcionamiento permanente.

Se suministra con un juego completo de pictogramas



DIMENSIONES

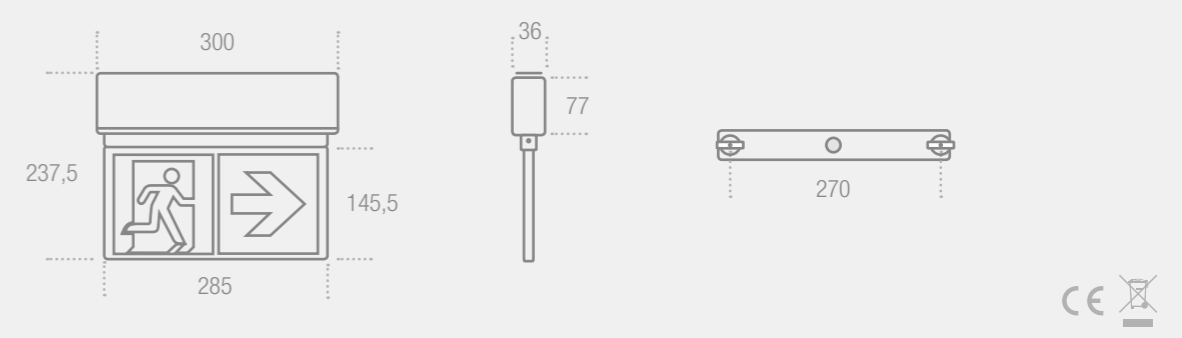

LUMINA

Máxima calidad en exit sign



REFERENCIAS

Lamp. (W)	Tipo*	Aut. (h)	Batería	Autotest	PVR
LED	P	1	4,8V 1,1A/h NiMh	LLS3450EXP	250,56€
LED	P	1	4,8V 1,1A/h NiMh	LLT3450EXP	255,56€

*P: funcionamiento permanente.

LUMINARIA

Lamp. (W)	Tipo	Luminaria	PVR
LED	230Vac	LLS34523	210,45€
LED	230Vac	LLT34523	210,45€

LUMINA
ZEMPER



La luminaria se suministra con un pictograma serigrafiado



Pic. Lum. 1
Hombre flecha derecha



Pic. Lum. 2
Hombre flecha izquierda



Pic. Lum. 3
Hombre flecha abajo

Al solicitar una luminaria debe indicar la referencia de la luminaria + la opción de pictogramas deseada. Ej.: LLS3450EXP + Pic. Lum. 1

DIMENSIONES

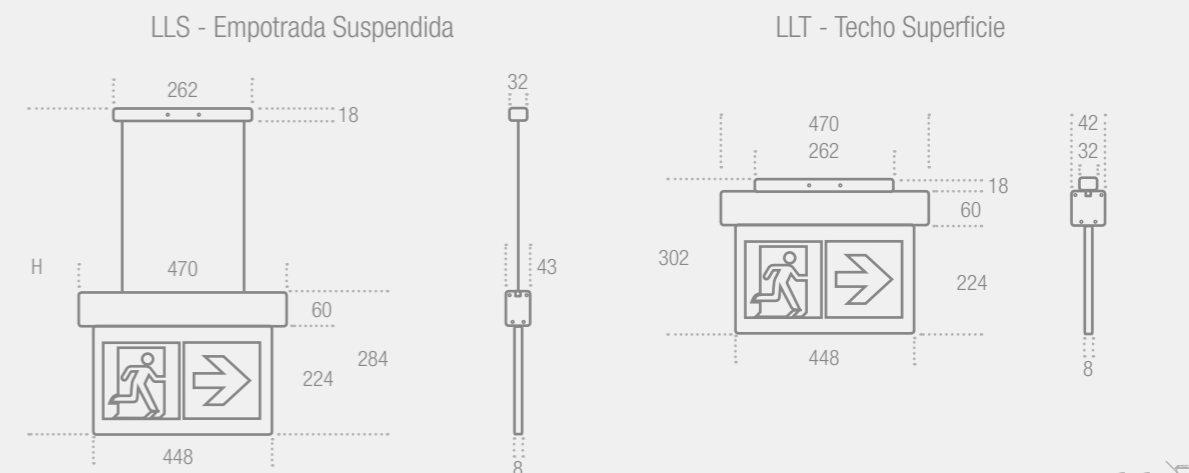



APLICACIONES ESPECIALES

ZEMPER

IP65 de aspecto convencional, que destaca por su gran robustez y solidez



DIMENSIONES



REFERENCIAS

Im	Tipo*	Aut. (h)	Batería	Estándar	PVR	Autotest	PVR	Wireless	PVR
100	NP	1	3,6V 0,8Ah Ni-Cd	LAE9100C	30,06€				
150	NP	1	3,6V 0,8Ah Ni-Cd	LAE9150C	33,06€				
225	NP	1	3,6V 1,6A/h Ni-Cd	LAE9200C	38,56€				
315	NP	1	3,6V 1,6A/h Ni-Cd	LAE9300C	43,06€				
500	NP	1	6V 1,6A/h Ni-Cd	LAE9500C	55,89€				
100	P/NP	1	3,6V 0,8A/h Ni-Cd	LAE9100CP	51,66€				
150	P/NP	1	3,6V 0,8A/h Ni-Cd	LAE9150CP	53,06€				
315	P/NP	1	3,6V 1,6A/h Ni-Cd	LAE9300CP	67,56€				
150	P/NP	2	3,6V 1,6A/h Ni-Cd	LAE9150CP2	59,56€				
325	P/NP	2	3,6V 2,0A/h Ni-Cd	LAE9300CP2	88,06€				
100	P/NP	1	3,2V 0,8A/h LFP			LAE9100LXP	60,58€	LAE9100LDPW	93,58€
150	P/NP	1	3,2V 0,8A/h LFP			LAE9150LXP	62,58€	LAE9150LDPW	96,58€
315	P/NP	1	3,2V 1,5A/h LFP			LAE9300LXP	74,99€	LAE9300LDPW	107,99€
500	P/NP	1	6,4V 1,5A/h LFP			LAE9500LXP	89,56€	LAE9500LDPW	122,56€
150	P/NP	2	3,2V 1,5A/h LFP			LAE9150LXP2	65,89€	LAE9150LDP2W	100,49€
325	P/NP	2	3,2V 3,0A/h LFP			LAE9300LXP2	92,56€	LAE9300LDP2W	125,56€

BAJAS TEMPERATURAS

Im	Tipo*	Aut. (h)	Batería	Estándar	PVR	Autotest	PVR
315	P/NP	1	3,6V 1,6A/h Ni-Cd	LAC9300CP**	112,56€		
315	P/NP	1	3,2V 1,5A/h LFP			LAC9300LXP	120,99€

*NP: funciona solo en caso de ausencia de red.

*P/NP: Posibilidad de funcionamiento permanente o no permanente mediante tercera borna de selección.

** Referencia especial para cámaras frigoríficas.

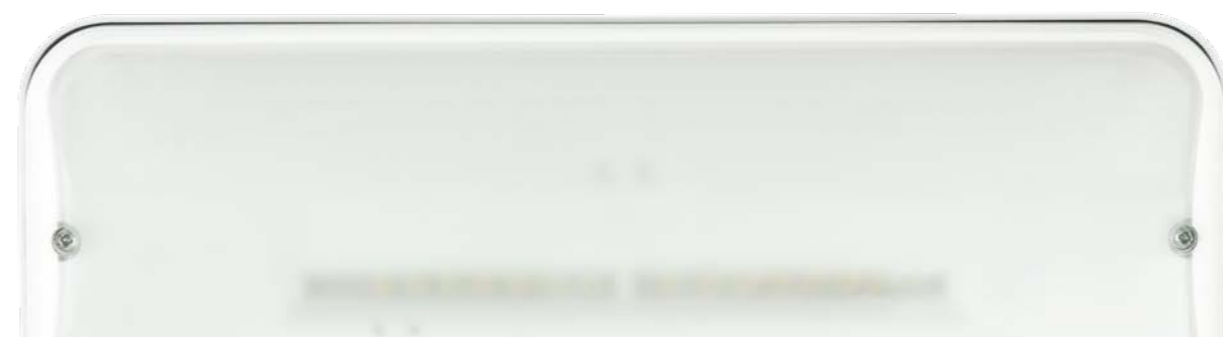

ACCESORIOS



ADBA008
Conjunto difusor y banderola ArianE
27,50€



AGA230
Rejilla protección
23,14€

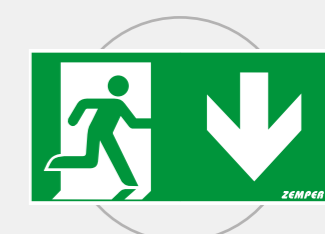

APA8(XX)
Pictograma señalización
3,00€

NEPTUNO

NEPTUNO
ZEMPER

Estanqueidad con base de acero inox para ganar en prestaciones



DIMENSIONES



REFERENCIAS

lm	Tipo*	Aut. (h)	Batería	Autotest	PVR
150	P/NP	1	3,2V 0,8A/h LFP	LNE9150LXP	104,78€
315	P/NP	1	3,2V 1,5A/h LFP	LNE9300LXP	124,99€
500	P/NP	1	6,4V 1,5A/h LFP	LNE9500LXP	147,56€
150	P/NP	2	3,2V 1,5A/h LFP	LNE9150LXP2	116,99€
325	P/NP	2	3,2V 3,0A/h LFP	LNE9300LXP2	149,46€

BAJAS TEMPERATURAS

lm	Tipo*	Aut. (h)	Batería	Autotest	PVR
315	P/NP	1	3,2V 1,5A/h LFP	LNC9300LXP	170,49€

*P/NP: Posibilidad de funcionamiento permanente o no permanente mediante tercera borna de selección.

ACCESORIOS



AGA230
Rejilla
protección
23,14€



CNC025
Difusor vidrio
Neptuno
(amb.agresivos)
19,95€



APA8(XX)
Pictograma
señalización
3,00€

MAXILUM

Proyector LED de gran rendimiento.

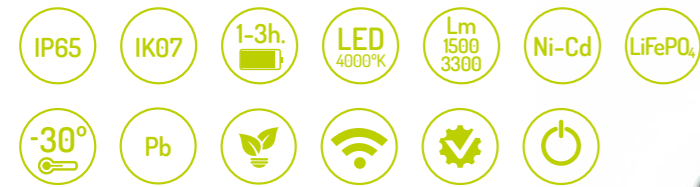

REFERENCIAS

lm	Tipo*	Aut. (h)	Batería	Estándar	PVR	Autotest	PVR	Wireless	PVR
1500	NP	1	PB12V-9A/h	PME1500BC	282,48€				
1500	NP	3	PB12V-9A/h	PME1500BC3	315,63€				
1500	NP	1	12V / 4Ah Ni-Cd	PME1500C	305,87€				
1500	NP	3	12V / 7Ah Ni-Cd	PME1500C3	371,14€				
1500	NP	1	12,8V / 3Ah LFP			PME1500LX	350,89€	PME1500LDW	400,89€
1500	NP	3	2 x 12,8V / 3Ah LFP			PME1500LX3	376,56€	PME1500LD3W	426,56€
3000	NP	1	PB12V-9A/h	PME3000BC	330,63€				
3250	NP	1	12V / 7Ah Ni-Cd	PME3000C	367,84€				
3300	NP	1	2 x 12,8V / 3Ah LFP			PME3000LX	421,56€	PME3000LDW	471,56€

BAJAS TEMPERATURAS

lm	Tipo*	Aut. (h)	Batería	Autotest	PVR	Wireless	PVR
3250	NP	1	12V / 7Ah Ni-Cd	PME3000XF	481,60€	PME3000DWF	531,60€

*NP: funciona solo en caso de ausencia de red.

DIMENSIONES

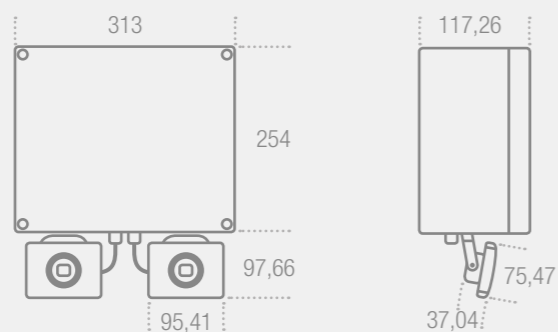

PFL

Proyector LED de gran rendimiento.



REFERENCIAS

lm	Tipo*	Aut. (h)	Batería	Estándar	PVR	Autotest	PVR	Wireless	PVR
1500	NP	1	12V / 4 Ah Ni-Cd	PFL1500C	245,87€				
1500	NP	1	12,8V / 3Ah LFP			PFL1500LX	265,89€	PFL1500LDW	305,89€

*NP: funciona solo en caso de ausencia de red.

DIMENSIONES

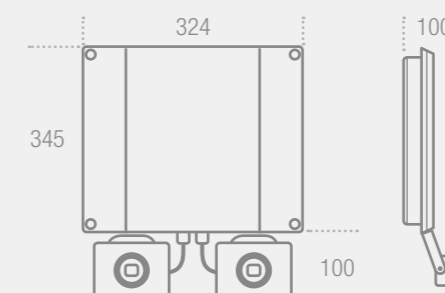



Ex db IIC T6 Gb
Ex tb IIIC T85°C Db

Normativa ATEX. Para un uso en atmósferas potencialmente explosivas.
No permanente, Permanente e Iluminación



ILUMINACIÓN

Dimensiones	Envolvente de Policarbonato	Lúmenes	PVR	Envolvente de Vidrio	Lúmenes	PVR
E1	LSIPC1100	1200	490,07€	LSIVC1100	1275	555,03€
E1	LSIPC1200	2100	520,54€	LSIVC1200	2400	585,55€
E2	LSIPC2200	2400	574,83€	LSIVC2200	2550	732,95€
E2	LSIPC2400	4600	623,83€	LSIVC2400	4800	787,57€
E3	LSIPC3400	4600	761,77€	LSIVC3400	4800	997,89€

ILUMINACIÓN DE EMERGENCIA - Envolvente de Policarbonato

Dimensiones	Tipo*	Envolvente	Lm. Ilum. / Lm. Emer.	Batería (Ni-Cd)	Autonomía	PVR
E1	NP	LSPC1400X	350	3,6V 1,6Ah	1h	619,85€
E1	P/NP	LSPC1700XP	2100 / 750	6V 1,6Ah	1h	719,84€
E2	NP	LSPC2700X	750	6V 1,6Ah	1h	713,07€
E2	P/NP	LSPC2700XP	4600 / 750	6V 1,6Ah	1h	826,65€
E3	P/NP	LSPC3700XP	4600 / 750	6V 1,6Ah	1h	963,54€
E1	NP	LSPC1400X3	350	3,6V 4Ah	3h	632,00€
E1	NP	LSPC1700X3	750	6V 4Ah	3h	663,19€
E2	NP	LSPC2700X3	750	6V 4Ah	3h	736,94€
E2	P/NP	LSPC2700XP3	4600 / 750	6V 4Ah	3h	833,58€
E3	P/NP	LSPC3700XP3	4600 / 750	6V 4Ah	3h	987,91€

ILUMINACIÓN DE EMERGENCIA - Envolvente de Vidrio

Dimensiones	Tipo*	Envolvente	Lm. Ilum. / Lm. Emer.	Batería (Ni-Cd)	Autonomía	PVR
E1	NP	LSVC1400X	400	3,6V 1,6Ah	1h	671,60€
E1	P/NP	LSVC1700XP	2400 / 800	6V 1,6Ah	1h	767,69€
E2	NP	LSVC2700X	800	6V 1,6Ah	1h	893,36€
E2	P/NP	LSVC2700XP	4800 / 800	6V 1,6Ah	1h	1.020,58€
E3	P/NP	LSVC3700XP	4800 / 800	6V 1,6Ah	1h	1.177,05€
E1	NP	LSVC1400X3	400	3,6V 4Ah	3h	684,14€
E1	NP	LSVC1700X3	800	6V 4Ah	3h	728,09€
E2	NP	LSVC2700X3	800	6V 4Ah	3h	910,47€
E2	P/NP	LSVC2700XP3	4800 / 800	6V 4Ah	3h	1.017,61€
E3	P/NP	LSVC3700XP3	4800 / 800	6V 4Ah	3h	1.208,90€

*NP: funciona solo en caso de ausencia de red.

*P/NP: Posibilidad de funcionamiento permanente o no permanente mediante tercera borna de selección.

DIMENSIONES

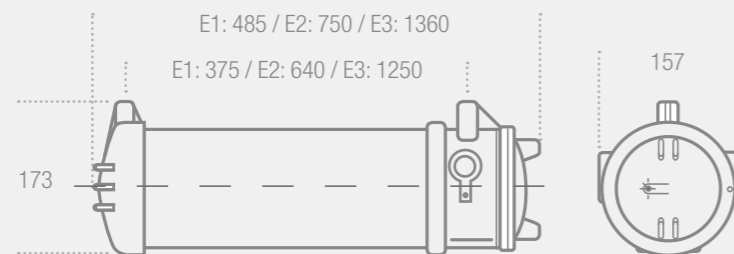

ACCESORIOS



CAM001
Cántamo para
instalaciones
suspendidas
4,80€

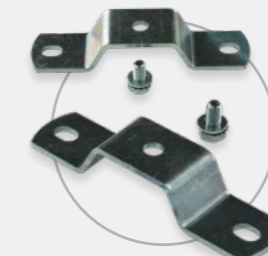

BRD001
Brida para
instalaciones
de superficie
15,60€



PSA001
Prensaestopa
para cable
armado
15,20€





BALIZADOS

ZEMPER

VULCANO

La forma redonda en balizado



REFERENCIAS

lm	Tipo*	Aut. (h)	Batería	Estándar	PVR	Luminaria	PVR
5	NP	3	2x1.2V-0.3Ah Ni-Cd	LPV5591	20,48€		
5	Central	-	-	LPV1031	11,17€		
5	Cortesia 230/48/24	-	-			LPV1051	11,11€

*NP: funciona solo en caso de ausencia de red.

Referencias válidas para color blanco. Para solicitar otros colores consultar al departamento comercial.

DIMENSIONES

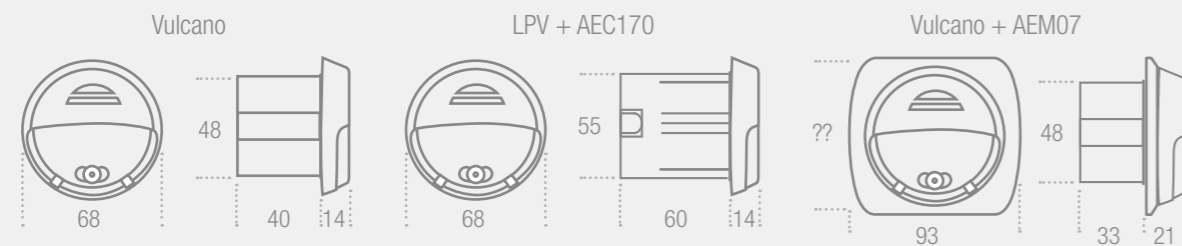

ACCESORIOS



AEC170
Caja Empotrar Corta
0,65€



AEM07(X)
Marco Embellecedor
Cuadrado colores
5,15€



VIGIA

Luminaria de balizado de mayor tamaño



REFERENCIAS

lm	Tipo*	Aut. (h)	Batería	Estándar	PVR	Luminaria	PVR
5	NP	3	2x1.2V-0.3Ah Ni-Cd	LVA0011	21,43€		
5	Central	-	-	LPC1021	9,39€		
5	Cortesia 230/48/24	-	-			LPC1053	9,55€

*NP: funciona solo en caso de ausencia de red.

Referencias válidas para color blanco. Para solicitar otros colores consultar al departamento comercial.

DIMENSIONES

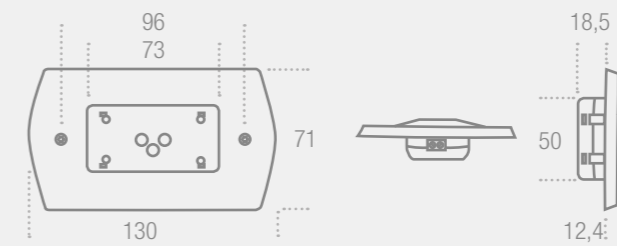

ACCESORIOS



AEP0011
Caja Empotrar
0,65€



ORION

Estéticamente diferente



REFERENCIAS

Im	Tipo*	IP	Aut. (h)	Batería	Estándar	PVR	Luminaria	PVR
5	NP	IP22	3	2x1.2V-0.3Ah Ni-Cd	LPO0031	19,02€		
5	Central	IP22	-	-	LPO1031	10,31€		
5	Cortesia 230/48/24	IP22	-	-			LPO1051	10,79€
5	NP	IP65	3	2x1.2V-0.3Ah Ni-Cd	LPO3531	23,04€		
5	Central	IP65	-	-	LPO4531	18,15€		
5	Cortesia 230/48/24	IP65	-	-			LPO4551	16,29€

*NP: funciona solo en caso de ausencia de red.

Referencias válidas para color blanco. Para solicitar otros colores consultar al departamento comercial.

DIMENSIONES

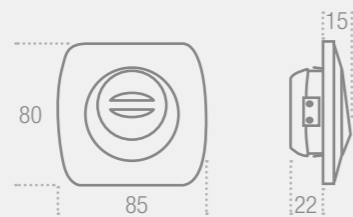

MINIMINOR

Minimalismo en balizados



REFERENCIAS

Lamp. (W)	Tipo	Luminaria	PVR
Led 24Vdc	Central	LMNASI200030I	30,34€

Consumo máximo 0,4W

DIMENSIONES

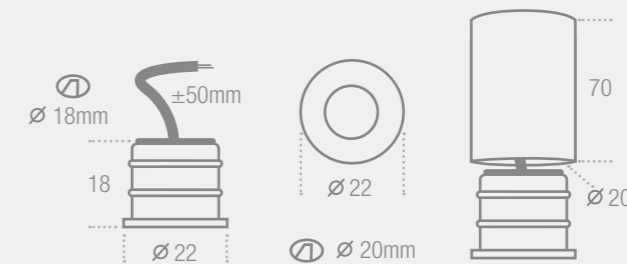

TRAZE

Minimalismo en balizados



REFERENCIAS

Lamp. (W)	Tipo	Luminaria	PVR
Led 12Vdc	Central	LTRAS100010I	17,16€

Consumo máximo 0,3W

DIMENSIONES

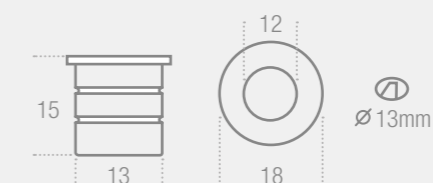

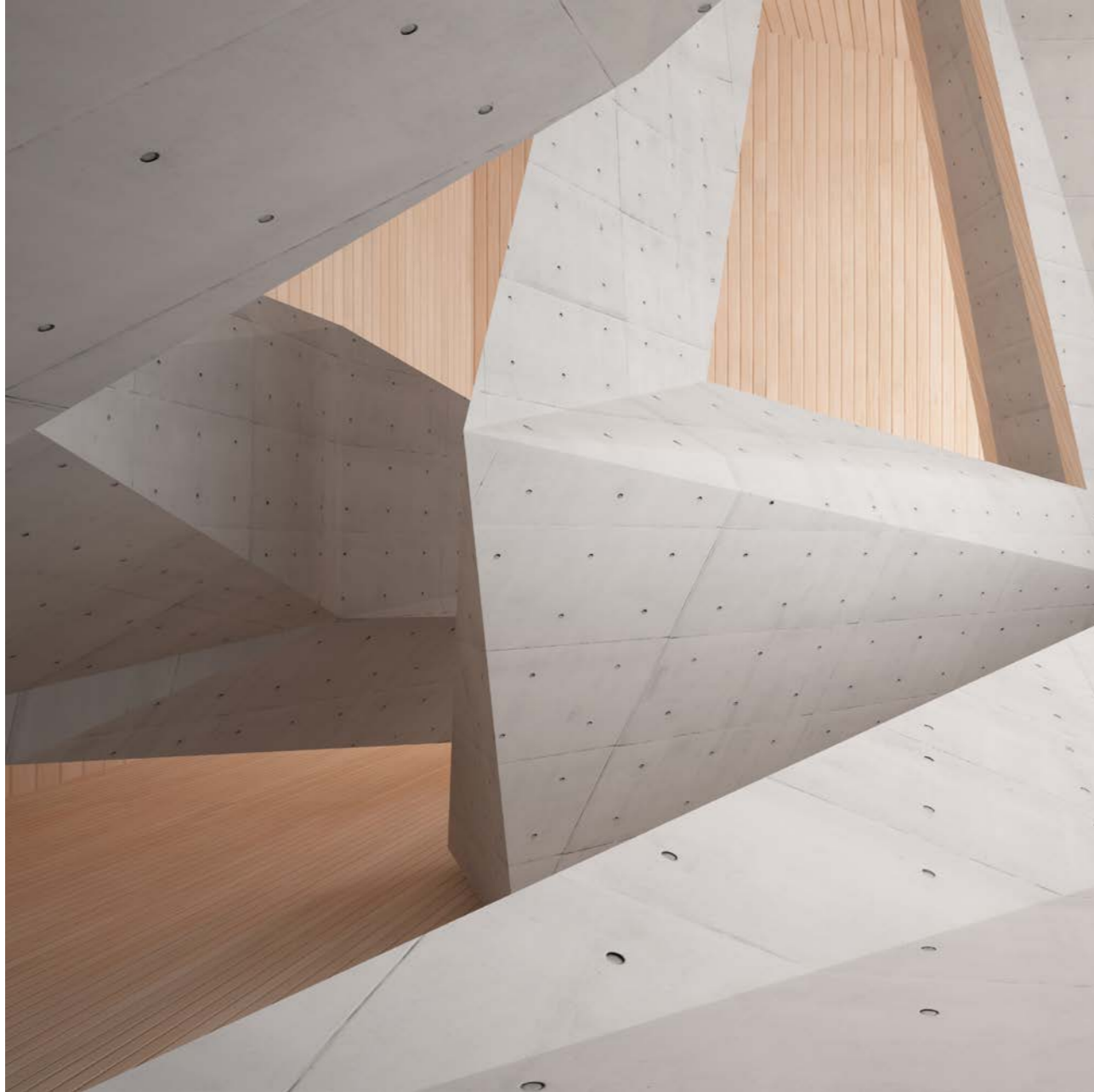

OTROS PRODUCTOS

ZEMPER

CENTRAL DE ALIMENTACIÓN LPE

Central de alimentación para balizados



Salida	Tipo*	Aut. (h)	Baterías	Ref.	PVR
24Vdc 30W	P	1	2x12V-1.6Ah Ni-Cd	LPE080	321,86€
12Vdc 20W	P/NP	1	2x12V-1.6Ah Ni-Cd	LPE150	265,56€
12Vdc 60W	P/NP	1	2x12V-4.0Ah Ni-Cd	LPE160	315,59€

*P: funcionamiento permanente.

*P/NP: Dispone de doble alimentación. Alimentación principal y alimentación independiente para habilitar/deshabilitar la función permanente.



DIMENSIONES

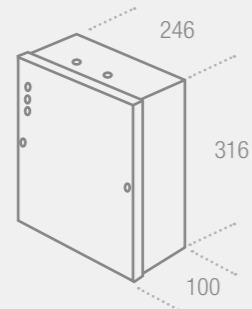

TELEMANDO ESTÁNDAR

ZEMPER

TMS300

Descripción

Telemando Estandar ZC y ZX 300 Luminarias

Uds. Caja	Referencia	PVR
1	TMS300	65,90€



TELEMANDO REPETIDOR

ZEMPER

TMR300D+

Descripción

Telemando repetidor zona ZD+ 250 Lm. RS485

Uds. Caja	Referencia	PVR
1	TMR300D	338,35€



MÓDULO DE ALIMENTACIÓN LPD

Modulo de alimentación para balizados



Salida	Tipo*	Aut. (h)	Baterías	Ref.	PVR
LPV-LPC-LPO	NP	1	4,8V 1,6A/h Ni-Cd	LPD20	197,05€
LPV-LPC-LPO	NP	1	4,8V 1,6A/h Ni-Cd	LPD50	259,66€

*NP: funciona solo en caso de ausencia de red.

MODULOS DE ALIMENTACIÓN

ZEMPER

KLM1250T

Descripción

KLM Modulos Alimentación

Uds. Caja	Referencia	PVR
1	KLM1250T	104,77€

Lamp. (W)	Tipo*	Aut. (h)	Batería
Led<35W	NP	1	12V 4A/h Ni-Cd

*NP: funciona solo en caso de ausencia de red.

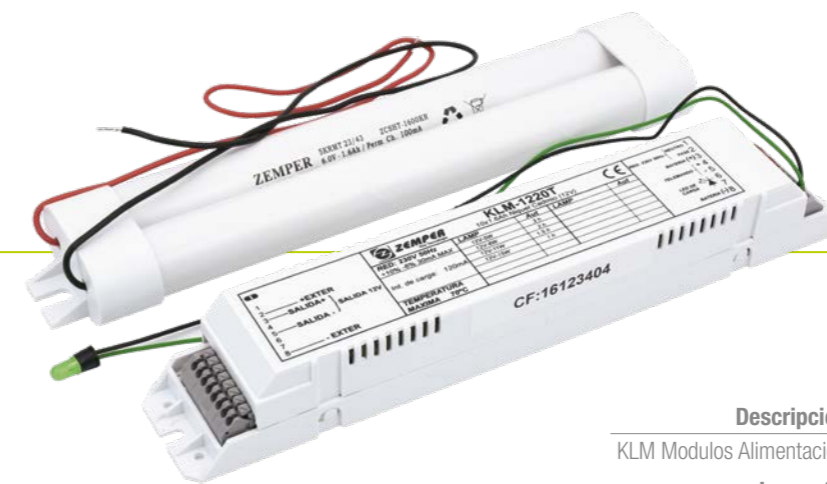

CENTRAL GESTIÓN PC

CWS8125W

ZEMPER



Descripción	Batería	Uds. Caja	Referencia	PVR
Central Gestión PC ZD+/ZDW 8 Zonas (130x8)	6,4V 1,5A/h LFP	1	CWS8125W	1.250,56€

Incluye un concentrador interno.

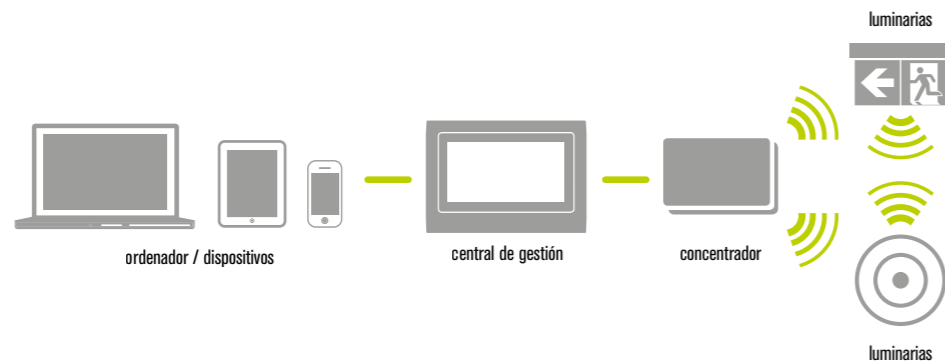

Gestión inteligente de hasta 1.040 luminarias de emergencia



CONCENTRADOR INALÁMBRICO

ZEMPER

CTE250M

Descripción	Batería	Uds. Caja	Referencia	PVR
Concentrador Inalámbrico ZDW 130 Luminarias	6V 1,6A/h Ni-Cd	1	CTE250M	111,39€

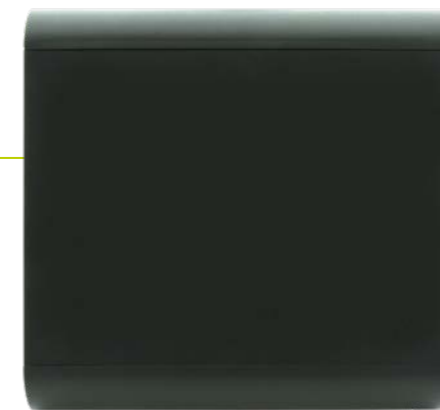

CAJA DE CONEXIONES

ZEMPER

CCWS001

Descripción	Uds. Caja	Referencia	PVR
Caja Conexiones CWS8125W	1	CCWS001	220,00€



MANDO PROGRAMADOR

ZEMPER

PZD250

Descripción	Uds. Caja	Referencia	PVR
Mando Programador Sistema ZD+ / ZDW	1	PZD250	475,45€

LÁMPARA BAPI LPORT02

LPORT02

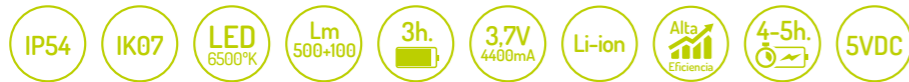

Características

- Fuente luminosa:
10 LED x 0,5W para la lámpara principal (emergencia)
1 LED x 1 W para la linterna
- Flujo luminoso:
Lámpara principal 500 lm
Linterna 100 lm
- Difusor: Policarbonato
- Temperatura de color: 6500°K
- Temperatura de funcionamiento: -10°C a +40°C
- Batería: 3,7V – 4400 mAh Li-ion
- Alimentación:
Cargador con toma USB
USB AC/DC Entrada 100v-240V, 50-60 Hz. Salida 5VDC 1000 mA
- Tiempo de carga: 5 horas
- Autonomía:
3 horas para la lámpara principal
Hasta 15 horas para linterna
- Funcionamiento: Normal y emergencia

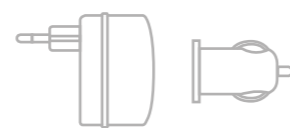

Suministrado con Cargador AC/DC

Descripción	Batería	Uds. Caja	Referencia	PVR
Bloque Autónomo Portátil para Intervención	3,7V – 4400 mAh Li-ion	1	LPORT02	50,00€



Lámpara Linterna Gancho para colgar Clip Cinturón Soporte para superficie plana Imán para fijación en superficie metálica

MARCOS UNIVERSALES

Para que todo encaje



MARCO UNIVERSAL XENA/DIANA para huecos de 8W

Marco compatible para modelos de las series DIANA y XENA.



Para medida máx. recomendada 365x132 mm

MARCO UNIVERSAL SPAZIO para huecos de 6W

Marco compatible para cualquier modelo de nuestra serie SPAZIO.



Para medida máx. recomendada 254x90 mm

MARCO UNIVERSAL XENA/DIANA + LUMINARIA SPAZIO para huecos de 8W+SPAZIO

Con esta opción puede pasar de una luminaria de 8W Fluor o LED a una luminaria de la serie Spazio.



Para medida máx. recomendada 365x132 mm

Descripción	Referencia	PVR
MARCO UNIVERSAL XENA/DIANA	AMU8001	7,50€
MARCO UNIVERSAL SPAZIO	AMU8002	6,50€
MARCO UNIVERSAL XENA/DIANA + LUMINARIA SPAZIO	AMU8001+AMU8002	14,00€

PICTOGRAMAS

Una nueva forma de entender la iluminación de emergencia



16



17



18



19



APT316

Descripción	Dimensiones	Uds. Caja	Referencia	PVR
Pictogramas Señalización	297x105 mm.	1	APA8(XX)	3,00€
Pictogramas Señalización	196x98 mm.	1	APT3(XX)	3,00€
Pictogramas Universal Triple	98x98 mm.	1	APT316	4,80€
Pictogramas Señalización	240x92 mm.	1	APV6(XX)	1,60€

Para la elección del pictograma, sustituir XX por los códigos del pictograma deseado

CONDICIONES DE VENTA

Pedidos

Cualquier pedido implica la aceptación de nuestras condiciones generales de venta, sean cual sean las cláusulas que figuran en los documentos del cliente. Los pedidos deben ser confirmados por escrito. La mercancía se suministrará en embalajes completos.

Precio

Los precios de venta serán los de la tarifa vigente en el momento de la entrega salvo condiciones especiales pactadas con anterioridad. Los precios podrán ser revisados en cualquier momento en función de la variación del coste de sus elementos constitutivos.

Portes

Los portes serán pagados para cualquier pedido superior a un neto de factura, antes de impuestos, de 360 euros, (600 euros para Canarias).

Para pedidos inferiores al citado importe, la mercancía será enviada a portes debidos.

La mercancía enviada a portes pagados se efectuará por el medio elegido por Electrozemper S.A. Cualquier otro medio indicado por el cliente será a cargo de éste.

La mercancía viaja a cuenta y riesgo del cliente, fuera cual fuera la forma de envío. En ningún caso se podrá exigir a Electrozemper S.A. responsabilidad alguna por daños en el material por culpa del transporte.

Plazos

Los plazos de entrega previamente pactados se respetarán salvo causas de fuerza mayor, en cuyo caso se notificará al cliente la demora con anticipación. En el caso de no haberse pactado ningún plazo de entrega los pedidos se servirán rigurosamente por el orden de llegada.

Los retrasos de entrega no serán, en ningún caso, motivo de rechazo de las mercancías ni objeto de penalización.

Facturación y condiciones de pago

El importe mínimo de facturación será de 360 euros. Para pedidos inferiores a esta cantidad los precios se verán incrementados en un 10% sobre el precio habitual de compra.

Los pagos se efectuarán de acuerdo con la ley 15/2010 del 05 - 07

I.V.A.

Se aplicará el vigente en cada momento.

Propiedad

Todo material suministrado y facturado por Electrozemper, S.A. es de su propiedad hasta que haya sido pagado el importe total.

Garantía

Todos los productos de este catálogo cuentan con una garantía de 2 años a partir del momento de la entrega, condicionada a un correcto almacenamiento, instalación y funcionamiento conforme a la normativa vigente.

No están incluidos en la citada garantía las lámparas y tubos, por considerarse elementos perecederos. Dicha garantía se verá perjudicada por la manipulación de los productos afectados por personal ajeno a Electrozemper S.A., a no ser que ésta lo haya autorizado expresamente por escrito.

La garantía se limita estrictamente a la sustitución o reparación del material reconocido defectuoso y devuelto a nuestra sede social, no dando en ningún caso lugar a reclamaciones por daños o perjuicios ocasionados por los defectos encontrados y/o cualquier tipo de gastos o indemnizaciones.

Los gastos de transporte correrán por cuenta del cliente.

La garantía excluye las averías generadas por una instalación incorrecta, manipulación inadecuada, negligencia o causas externas.

Devoluciones

No se aceptarán devoluciones sin la conformidad por escrito de Electrozemper S. A. y siempre indicando la factura de procedencia. Serán abonadas cumpliendo estos requisitos:

- Envío a portes pagados
- Embalajes originales
- Mercancía en perfecto estado
- Producto en vigor en el catálogo

No se admitirán devoluciones en ningún caso de los productos diseñados o que contengan alguna modificación especificada por el cliente.

Transcurridos 30 días desde la fecha de entrega, la mercancía se abonará con un demérito de un 15% en concepto de participación de los gastos de revisión y acondicionamiento.

Nuestras condiciones generales de venta priman sobre las condiciones generales de compra del Cliente, y sobre las que no estén aceptadas expresamente por Electrozemper S. A.

Cualquier disputa que pudiera surgir, fuera cual fuera su naturaleza o causa, estará sometida a la jurisdicción de los Tribunales de Ciudad Real, con exclusión de cualquier otro Fuero.



ZEMPER

ILUMINACIÓN DE EMERGENCIA

ZEMPER

Avda. de la Ciencia s/n · Pol. Industrial Avanzado
13005 Ciudad Real (España)

Tel. +34 902 11 11 97 · Fax +34 902 22 22 97
info@zemper.com

www.zemper.com