

Espacios
que inspiran...
iluminación
que complementa.

tecnolite[®]
ILUMINACIÓN

CATÁLOGO
DE PRODUCTOS
COLOMBIA

2022

*Espacios
que inspiran...
iluminación
que complementa.*

“Ten el control
sin estar en casa”

Iluminación inteligente

Ahora podrás controlar tus productos
vía WIFI por medio de una APP fácil y
sencilla de usar.



Tecnología wireless



Control por Voz



Crea Escenas

Descarga Aquí
la APP



Nomenclatura

Guía Lectura Referencias

Ejemplo:

20TLLED408MV30B

AN	Antracita
B	Blanco
BA	Bronce Antiguo
CA	Color Ambar
CH	Color Humo
CO	Cristal Cobre
CR	Cristal Cromo
G	Gris
GR	Grafito
N	Negro
NI	Niquel
PL	Plata
S	Satinado

Potencia (W)

20

D

Dimerizable

Familia

TL

YD	Balas de Techo, Downlights Cardans, Paneles
PTL	Plafones
YS/YSN/LVC	Spot Riel y Sobreponer
PAN	Paneles
LFC	Lineales
TL	Apliques de Pared
ETL	Luz de Cortesía
CTL	Colgantes
H/FTL	Exterior- Apliques de Muro
LQ	Reflectores
UFO	Industrial

ID

LED

Tecnología

408

MV

Multivoltaje

Color de Luz

30

20	2000 K
30	3000 K
40	4000 K
65	6500 K
RGB	Red,Green,Blue

B

Color Carcasa



Simbología

 Sobreponer Muro	Tipo de Aplicación
Negro	Color Carcasa
9 W	Potencia
3000K	Temperatura de Color
759 lm	Lúmenes
100-240 Voltaje	Voltaje
80 IRC	Índice de Reproducción Cromática
 30.000h	Horas de Vida
97 Grado de Apertura	Ángulo de Apertura
Aluminio Material Carcasa	Material Carcasa
54 IP	Índice de Protección



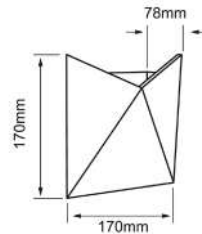

TITAWIN
09HLED923MV30N

[Descargar Archivos](#)



 Sobreponer Muro	Negro	9 W	3000K	759 lm	100-240 Voltaje	80 IRC	 30.000h	97 Grado de Apertura	Aluminio Material Carcasa
--	--------------	---------------	--------------	------------------	--------------------	------------------	--	--------------------------------	-------------------------------------

División Categorías

-  Iluminación Inteligente
-  Iluminación Interior
-  Iluminación Exterior
-  Bombillos

Iluminación Inteligente

	PAG
Panel	4
Bombillos	5
Mini Cardans	6
Aplique de Pared	10
Serie 4 estacas	11
Interruptores	12

2

Iluminación Interior

15

Balas de Techo	PAG
<i>Led Integrado</i>	16
<i>Requieren Bombillo</i>	17
DOWNLIGHTS	19
DOWNLIGHTS	28
CARDANS	32
<i>Led Integrado</i>	33
<i>Requieren Bombillo</i>	34
PANELES	38
<i>Incrustar</i>	39
<i>Sobreponer</i>	43
SPOTS	46
SPOTS TIPO RIEL	46
<i>Led Integrado</i>	47
<i>Requieren Bombillo</i>	48
<i>Accesorios</i>	51
SPOTS SOBREPONER	
<i>Led Integrado</i>	53
<i>Requieren Bombillo</i>	57
PLAFONES	60
APLIQUES DE PARED	64
<i>Led Integrado</i>	65
<i>Requieren Bombillo</i>	72
<i>Luz de Cortesía</i>	75
COLGANTES	76
<i>Led Integrado</i>	77
<i>Requieren Bombillo</i>	78
OFICINA	84
LINEALES	90
CINTAS LED	96
DRIVERS Y CONTROLADORES	108
ILUMINACIÓN DE EMERGENCIA	110
INDUSTRIAL	114

121

Iluminación Exterior

	PAG
APLIQUES DE MURO	122
<i>Led Integrado</i>	123
<i>Requieren Bombillo</i>	139
<i>Luz de Cortesía</i>	145
REFLECTORES	152
<i>Led Integrado</i>	153
<i>Requieren Bombillo</i>	157
Tipo Estaca	
<i>Led Integrado</i>	158
<i>Requieren Bombillo</i>	161
BALAS DE PISO	162
<i>Led Integrado</i>	163
<i>Requieren Bombillo</i>	166
SUMERGIBLES	168
MINIPOSTES	172
<i>Led Integrado</i>	173
<i>Requieren Bombillo</i>	177
CINTAS LED	178
REGLETA	182

185

	PAG
BOMBILLOS VINTAGE	187
PORTALÁMPARAS	198
MOON LIGHT	202
BOMBILLOS LED	203
ALTA POTENCIA	210
TUBOS LED	211

Bombillos

ÍNDICE



SMART HOME

Room Lighting



Video Security

on



Room Temp

- cam 1
- cam 2
- cam 3

Living room

Bedroom

Bathroom

Kitchen



ILUMINACIÓN

Inteligente

ILUMINACIÓN



Inteligente

Conoce nuestra línea de productos Inteligentes controlados vía WIFI y por una aplicación fácil y sencilla de usar, donde podrás monitorear lo que pasa en tu hogar o negocio dentro o fuera del mismo.

Compatible con más de 50 mil productos en el mercado, desde la APP controla, crea escenas y automatiza tus espacios para vivir con mayor seguridad y comodidad.

DESCARGA LA APP



 amazon alexa
 Google Assistant



*CONTROLA CUANDO
Y DESDE DONDE QUIERAS..*



TECNOLOGÍA WIRELESS WIFI

- No necesita cables, ni ninguna instalación especial
- Instalación en 30 Segundos



CONTROLADOR POR VOZ

Una vez configurado el sistema puedes controlar lo que ocurre en tu hogar o negocio, sólo pídelo. Activa, arma, enciende, apaga, atenúa con un simple comando de voz a través de Alexa, Google Home o atajos de Siri.



CREA ESCENAS

Crea momentos perfectos con tus dispositivos para que interactúen como tu quieras y hacer tu vida increíble; como una escena de "Buenos Días", que encenderá tus luces poco a poco al sonar el despertador.



MULTI-USUARIO

Cualquiera puede tener el control. Configurar el sistema de nuevo solamente por el tiempo que tú decidas.



PROGRAMACIÓN

Automatización de acuerdo a tus necesidades. ¡Sal sin precauciones!. Activa dispositivos o escenas los días que tu quieras o activa las luces en horarios específicos para que parezca que tu casa está habitada mientras no estás.



MULTI-UBICACIÓN

No importa en cuántos lugares hayas instalado los dispositivos Tecnolite Connect (tu casa, la oficina, el negocio...) contrólalo todo mediante una sola aplicación y un solo perfil.



AHORRO DE ENERGÍA

Los dispositivos son de bajo consumo de energía por lo que las baterías durarán mucho tiempo. Las luminarias tienen tecnología LED y control de intensidad de 0 a 100%, tu consumo de electricidad será menor.



RECIBE NOTIFICACIONES

Tus dispositivos te avisarán, por medio de notificaciones a tu smartphone, cualquier tipo de evento, movimiento o alerta que esté ocurriendo en tu espacio.



MODO VACACIONES

Configura tus luces para parezca que tu casa está habitada mientras no te encuentres en ella; activa tus sensores, alarma y cámaras para proteger y monitorear todo lo que pasa dentro y fuera.



ACCESIBILIDAD REMOTA

La APP Tecnolite Connect da accesibilidad remota desde cualquier parte del mundo; así puedes prender, activar, monitorear, modificar o apagar los dispositivos en el momento que tú desees.

ATIK II
13YDLED011MVBTCW

[Descargar Archivos](#)

amazon alexa
Google Assistant

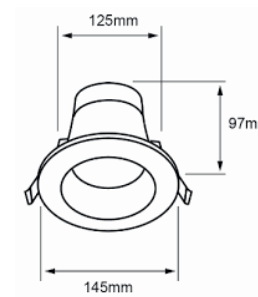

Interior



Elige el tono de luz



Dimerizable



WIFI



Control desde la APP



Incrustar Techo	Blanco	13 W	2700K / 6500K	910 lm	100-277 Voltaje	80 IRC	30.000h	90 Grado de Apertura	Polycarbonato Material Carcasa
-----------------	--------	------	---------------	--------	-----------------	--------	---------	----------------------	--------------------------------

BEAM SMART
5GU10LDMV35TCW

[Descargar Archivos](#)



amazon alexa
Google Assistant



Interior



WIFI



Dimerizable



Elige el tono de luz



Control desde la APP



5 W	2700K 6500K	410 lm	127 Voltaje	80 IRC	15.000h	45 Grado de Apertura	Plástico Material Carcasa
--------	----------------	-----------	----------------	-----------	---------	-------------------------	------------------------------

GLOW SMART
7A19LEDMV200TCW

[Descargar Archivos](#)

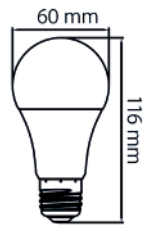

Interior

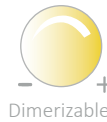

Dimerizable



Elige el tono de luz



WIFI



Control desde la APP

7 W	2700K 6500K	800 lm	127 Voltaje	80 IRC	15.000h	200 Grado de Apertura
--------	----------------	-----------	----------------	-----------	---------	--------------------------

COLORS SMART
8A19LEDMV200TCRGBW

[Descargar Archivos](#)

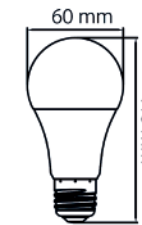

Interior



Elige el tono de luz



WIFI



Control desde la APP

8 W	RGB	800 lm	80 IRC	15.000h	200 Grado de Apertura
--------	-----	-----------	-----------	---------	--------------------------



LUCIDA I SMART
3YDLED3161MVBTCW
3YDLED3161MVNTCW

Descargar Archivos
Descargar Archivos

amazon alexa
Google Assistant

MiniCardan



Elige el tono de luz



Control desde la APP

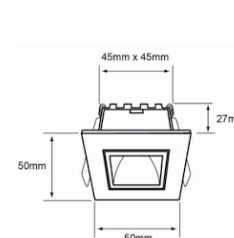

Incrustar Techo	Blanco Negro	3 W	2700K 6500K	115 lm	100-240 Voltaje	80 IRC	30.000h	34 Grado de Apertura	Aluminio Material Carcasa
-----------------	-----------------	--------	----------------	-----------	--------------------	-----------	---------	-------------------------	------------------------------

LUCIDA II SMART
6YDLED3162MVBTCW
6YDLED3162MVNTCW

[Descargar Archivos](#)

[Descargar Archivos](#)

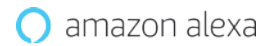

MiniCardan

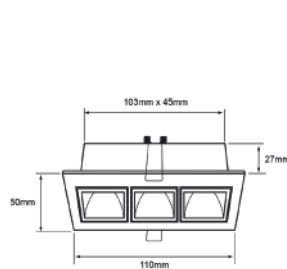

Incrustar Techo	Blanco Negro	6 W	2700K 6500K	235 lm	100-240 Voltaje	80 IRC	30.000h	34 Grado de Apertura	Aluminio Material Carcasa
-----------------	-----------------	--------	----------------	-----------	--------------------	-----------	---------	-------------------------	------------------------------

LUCIDA III SMART
 7YDLED3163MVBTCW
 7YDLED3163MVNTCW

[Descargar Archivos](#)
[Descargar Archivos](#)

MiniCardan

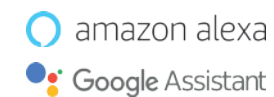

Elige el tono de luz



Control desde la APP

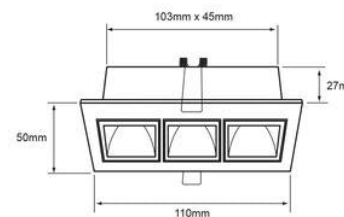

Incrustar Techo	Blanco Negro	7 W	2700K 6500K	305 lm	100-240 Voltaje	80 IRC	30.000h	34 Grado de Apertura	Aluminio Material Carcasa
-----------------	-----------------	--------	----------------	-----------	--------------------	-----------	---------	-------------------------	------------------------------

LUCIDA IV SMART
 17YDLED3165MVBTCW
 17YDLED3165MVNTCW

Descargar Archivos
 Descargar Archivos

MiniCardan

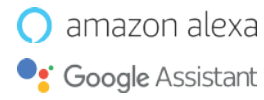

Elige el tono de luz

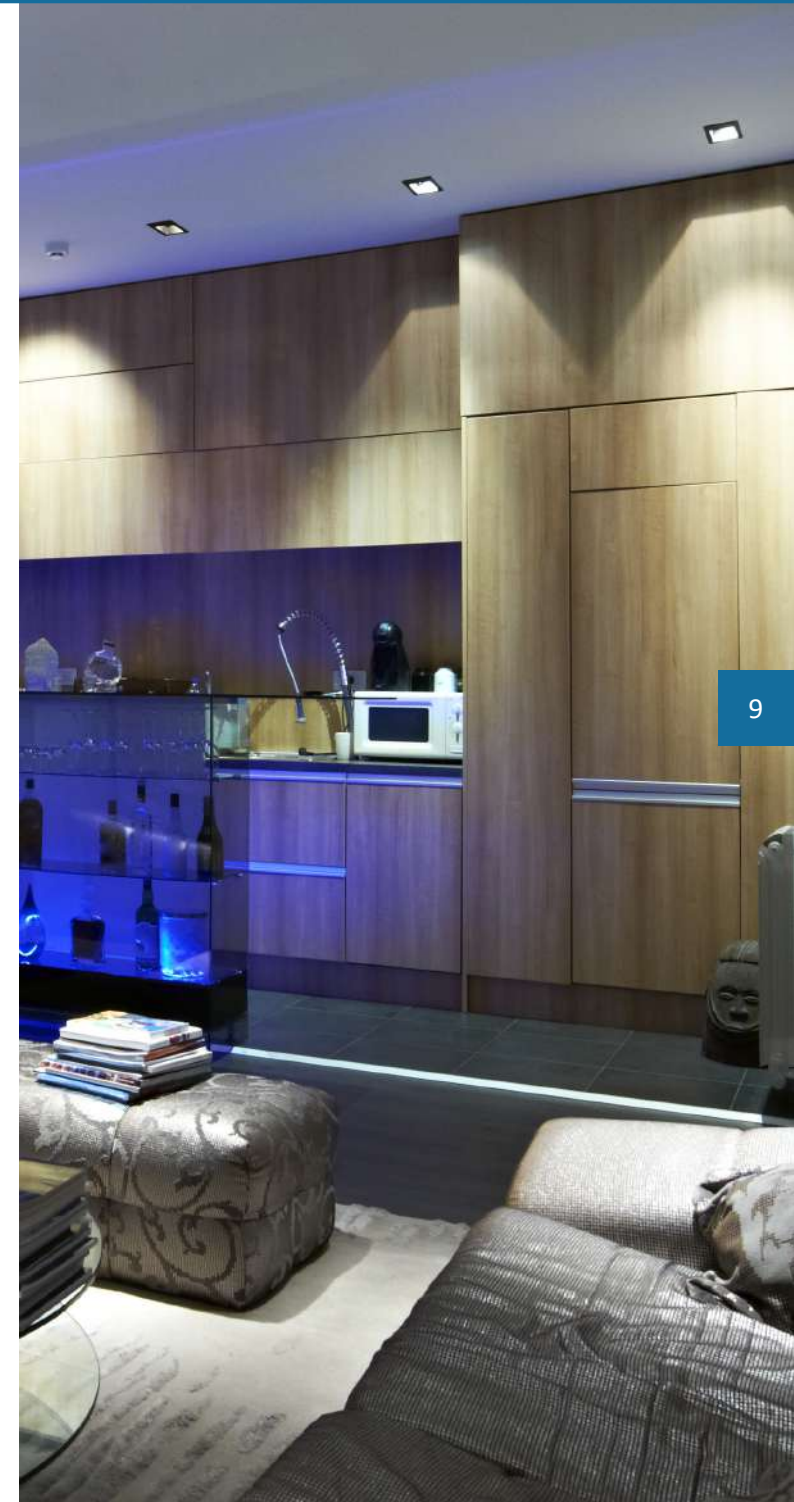
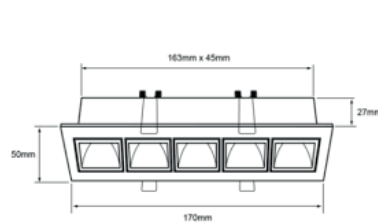

	Blanco Negro	17 w	2700K 6500K	730 lm	100-240 Voltaje	80 IRC	 30.000h	34 Grado de Apertura	Aluminio Material Carcasa
--	-----------------	---------	----------------	-----------	--------------------	-----------	-------------	-------------------------	------------------------------



CANCRI SMART
STLLED407MVNTCW

Descargar Archivos

amazon alexa
Google Assistant



Dimerizable



Interior



Elige el tono de luz



WIFI



Control desde la APP

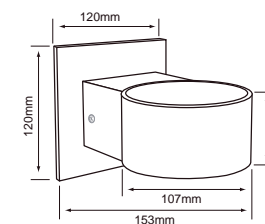

 Sobreponer Pared/Muro	Negro	5.5 W	3000K	315 lm	100-240 Voltaje	80 IRC	 25.000h	40 Grado de Apertura	Aluminio Material Carcasa
---------------------------	--------------	-----------------	--------------	------------------	--------------------	------------------	--------------------	--------------------------------	-------------------------------------

LIGHT GARLAND SMART
12HLED59RGBMVNTCW

Descargar Archivos

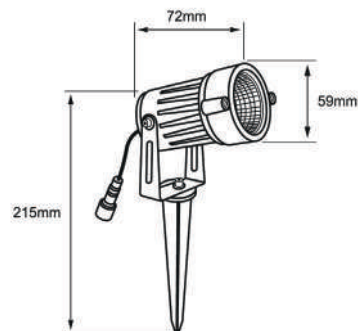

amazon alexa
 Google Assistant

EX
 Exterior

IP 65



Elige el tono de luz



Dimerizable



WIFI



Control desde la APP



 Piso / Estaca	Negro	12 W	 RGB	100-240 Voltaje	 20.000h	120 Grado de Apertura	Aluminio + ABS + PC Material Carcasa
--	--------------	----------------	--	--------------------	---	---------------------------------	---



CREATOR I
TSWI1MVBTCW

[Descargar Archivos](#)

SENCILLA

amazon alexa

Google Assistant



Interior



WIFI



Control desde la APP

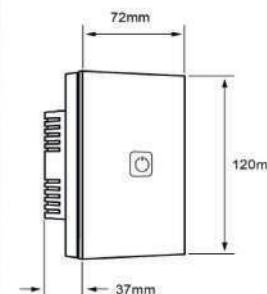

CREATOR II
TSWI2MVBTCW

[Descargar Archivos](#)

DOBLE

amazon alexa

Google Assistant



Interior



WIFI



Control desde la APP

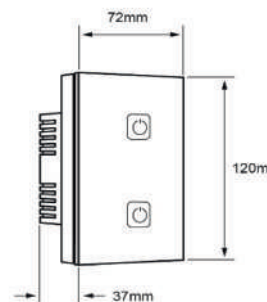

CREATOR III
TSWI3MVBTCW

[Descargar Archivos](#)

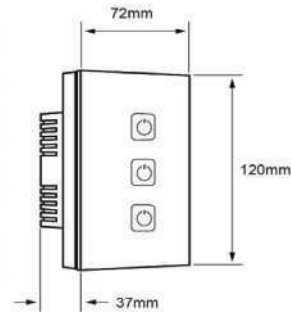

TRIPLE



Interior



WIFI



Control desde la APP

CREATOR II
TDSWI1MVBTCW

[Descargar Archivos](#)



Dimerizable

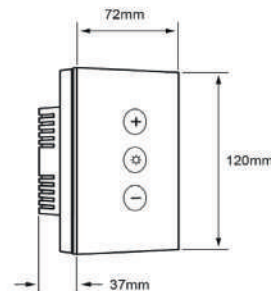

Interior



WIFI



Control desde la APP

JOINT
SPJ11MVBTCW

[Descargar Archivos](#)

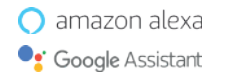
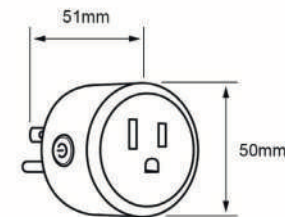

Interior



WIFI



Control desde la APP





ILUMINACIÓN
Interior



BALAS
DE *Techo*

IOTA
3DYDLED801V30B
3DYDLED801V30N

[Descargar Archivos](#)

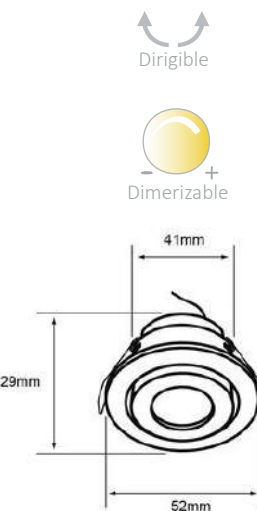

	Blanco Negro	3 W	3000K	120 lm	100-127 Voltaje	80 IRC	15.000h	90 Grado de Apertura	Aluminio Material Carcasa
--	-----------------	--------	-------	-----------	--------------------	-----------	---------	-------------------------	------------------------------

NAOS I
YDLED-154/30/B
YDLED-154/40/B
YDLED-154/65/B

[Descargar Archivos](#)



Dirigible



	Blanco	5.5 W	3000K 4000K 6500K	450 lm	100-240 Voltaje	70 IRC	15.000h	68 Grado de Apertura	Plástico Material Carcasa
--	--------	----------	-------------------------	-----------	--------------------	-----------	---------	-------------------------	------------------------------

TECTUM II
YDLEDR-005/30

[Descargar Archivos](#)



	Blanco	9 W	3000K	650 lm	100-240 Voltaje	80 IRC	25.000h	40 Grado de Apertura	Aluminio Material Carcasa
--	--------	--------	-------	-----------	--------------------	-----------	---------	-------------------------	------------------------------

ALTAIR I
YDLED-101/08/30B

[Descargar Archivos](#)

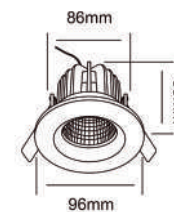

 Incrustar Techo	Blanco	6.5 W	3000K	540 lm	100-240 Voltaje	80 IRC	 15.000h	25 Grado de Apertura	Aluminio Material Carcasa
--	--------	----------	-------	-----------	--------------------	-----------	--	-------------------------	------------------------------

ALTAIR II
YDLED-102/08/30B

[Descargar Archivos](#)

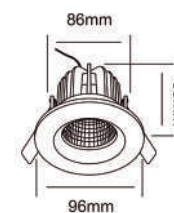

 Incrustar Techo	Blanco	6.5 W	3000K	540 lm	100-240 Voltaje	80 IRC	 15.000h	25 Grado de Apertura	Aluminio Material Carcasa
--	--------	----------	-------	-----------	--------------------	-----------	--	-------------------------	------------------------------

URANIUM I
10YDR002MVB
10YDR002MVN

[Descargar Archivos](#)

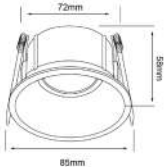

 Incrustar Techo	Blanco Negro	 No lo Incluye	Aluminio Material Carcasa
---------------------	-----------------	-------------------	------------------------------

URANIUM II
10YDC002MVB
10YDC002MVN

[Descargar Archivos](#)

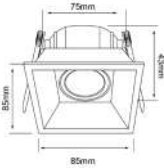

 Incrustar Techo	Blanco Negro	 No lo Incluye	Aluminio Material Carcasa
---------------------	-----------------	-------------------	------------------------------





ALMACH IV
60YD459MVB

[Descargar Archivos](#)

ALMACH V
60YD460MVB

[Descargar Archivos](#)

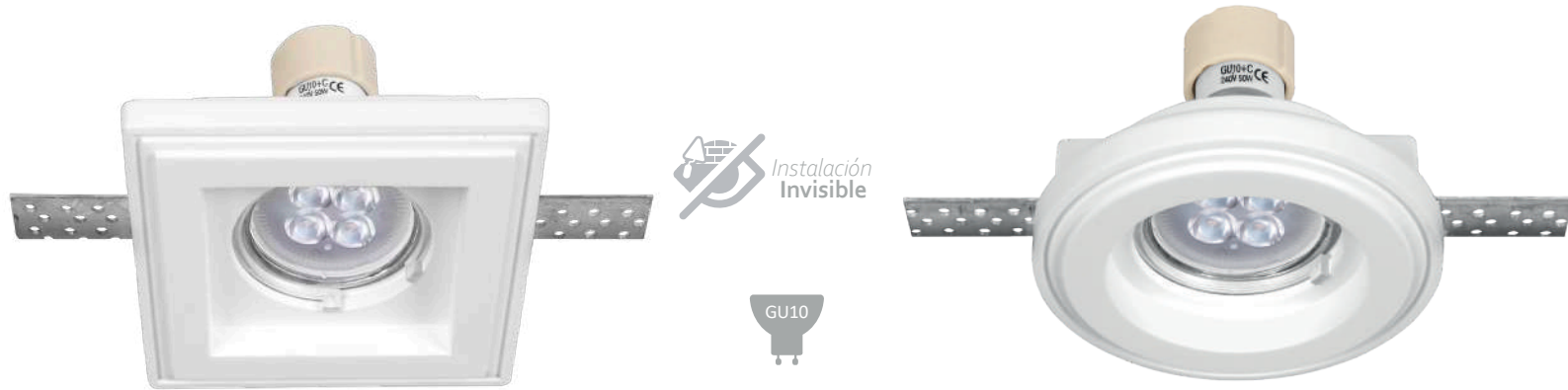

	Blanco		Yeso
Incrustar Techo		No lo Incluye	Material Carcasa

	Blanco		Yeso
Incrustar Techo		No lo Incluye	Material Carcasa



AHMEDABAD
YD-440

[Descargar Archivos](#)

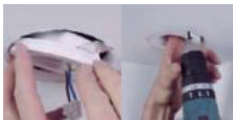

	Blanco		Yeso
Incrustar Techo		No lo Incluye	Material Carcasa

PASOS INSTALACIÓN INVISIBLE

1. Realiza el corte en tu Drywall y conecta la luminaria. 
2. Introduce la Luminaria y atornilla. 
3. Cubre los huecos con resina y limpia la superficie. 
4. Lija los bordes, pinta, deja secar y listo. 

ABSOLUNO I
60YDR1066MVB

[Descargar Archivos](#)

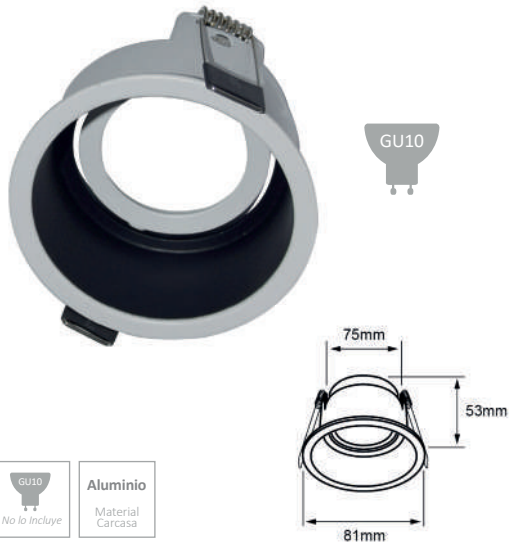

	Blanco Negro		Aluminio Material Carcasa
--	-------------------------------	--	--

ABSOLUNO II
60YDC1067MVB

[Descargar Archivos](#)

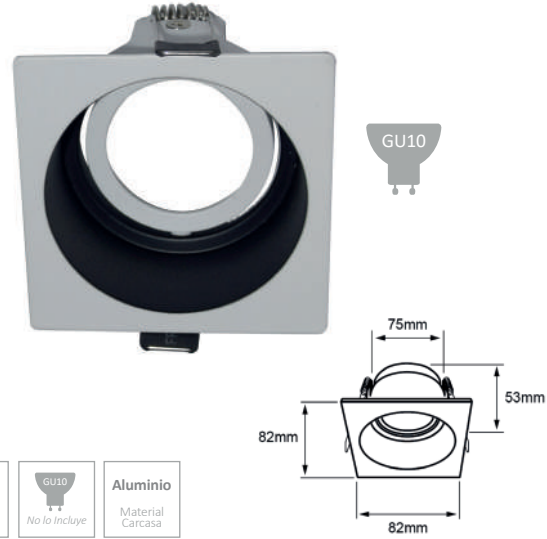

	Blanco Negro		Aluminio Material Carcasa
--	-------------------------------	--	--

ALASIA I
60YDR1068MVB

[Descargar Archivos](#)

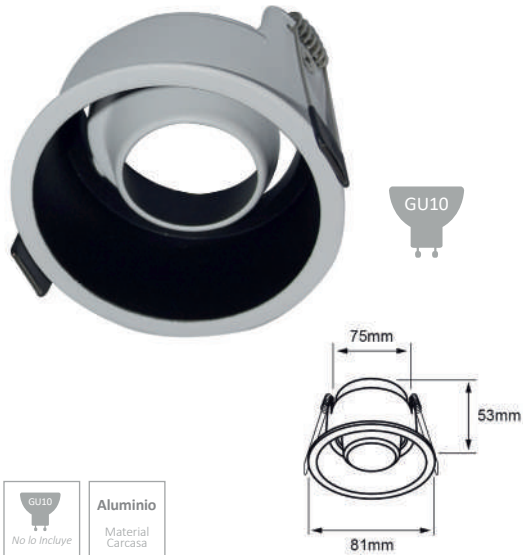

	Blanco Negro		Aluminio Material Carcasa
--	-------------------------------	--	--

ALASIA II
60YDC1069MVB

[Descargar Archivos](#)

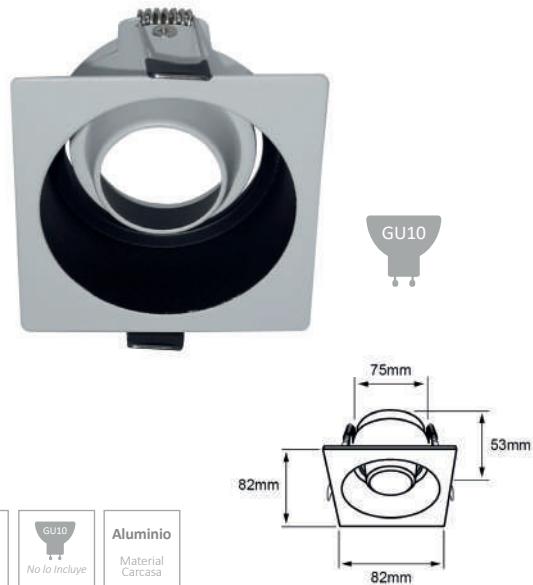

	Blanco Negro		Aluminio Material Carcasa
--	-------------------------------	--	--







ADRIA I
10YD101MVB
[Descargar Archivos](#)

Especial para Baños
y Zonas con Vapor

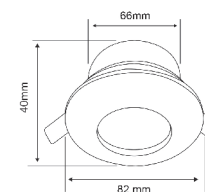

SOLARIUM
10YDR003MVB

Descargar Archivos

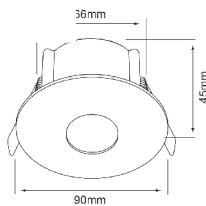
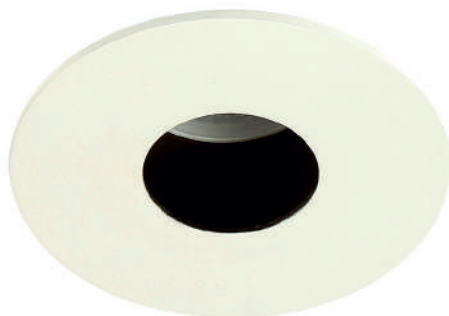

Incrustar Techo	Blanco	GU10 No lo Incluye	Aluminio Material Carcasa
-----------------	--------	-----------------------	------------------------------

ALEZIO
YD-220/B

Descargar Archivos

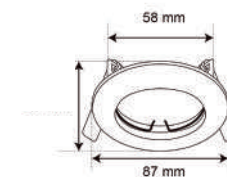

Incrustar Techo	Blanco	GU10 No lo Incluye	Lámina de Acero Material Carcasa
-----------------	--------	-----------------------	-------------------------------------

ACERRA
YD-360/B

Descargar Archivos

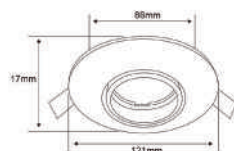

Incrustar Techo	Blanco	GU10 No lo Incluye	Aluminio Material Carcasa
-----------------	--------	-----------------------	------------------------------

AGRA
YD-905/B

Descargar Archivos

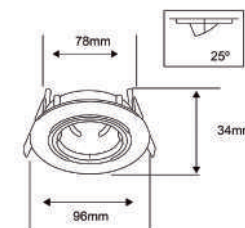

Incrustar Techo	Blanco	GU10 No lo Incluye	Aluminio Material Carcasa
-----------------	--------	-----------------------	------------------------------

Sujeción de Bombillo sin alambre.

RIGEL
60YD221MVB
60YD221MVN

Descargar Archivos

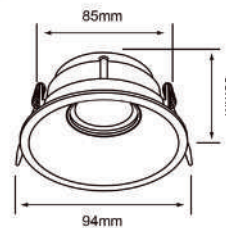

	Blanco Negro	 No lo Incluye	Aluminio Material Carcasa
--	-------------------------------	-------------------	-------------------------------------

ANDORA
YD-330/B
YD-330/N

Descargar Archivos

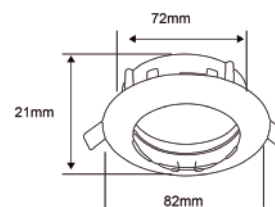

	Blanco Negro	 No lo Incluye	Aluminio Material Carcasa
--	-------------------------------	-------------------	-------------------------------------







DOWN
lights



KAMUY

20YDLED015MV30B
20YDLED015MV40B
20YDLED015MV30N
20YDLED015MV40N

[Descargar Archivos](#)

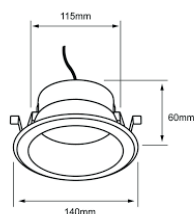

	Blanco Negro	20 w	3000K 4000K	1620lm 1800lm	100-277 Voltaje	80 IRC	 25.000h	90 Grado de Apertura	Plástico Material Carcasa
--	-----------------	---------	----------------	------------------	--------------------	-----------	-------------	-------------------------	------------------------------

ALIOTH I

YDLEDD-004/30
YDLEDD-004/40

[Descargar Archivos](#)



Dimerizable

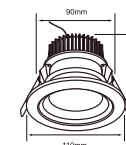

	Blanco	13 w	3000K 4000K	1100lm 1200lm	100-127 Voltaje	80 IRC	 40.000h	60 Grado de Apertura	Aluminio Material Carcasa
--	--------	---------	----------------	------------------	--------------------	-----------	-------------	-------------------------	------------------------------

ALIOTH II

YDLEDD-005/40

[Descargar Archivos](#)



Dimerizable

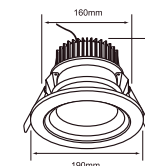

	Blanco	25 w	4000K	2400 lm	100-127 Voltaje	80 IRC	 40.000h	60 Grado de Apertura	Aluminio Material Carcasa
--	--------	---------	-------	------------	--------------------	-----------	-------------	-------------------------	------------------------------

ATIK
10DYDLED010VSCCTB

📄 Descargar Archivos

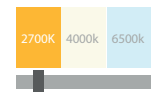

Selección de Temperatura con Switch



Dimerizable

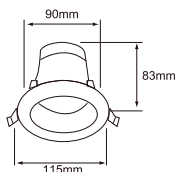

	Blanco	10 W	2700K 4000K 6500K	700 lm	127 Voltaje	80 IRC	30.000h	90 Grado de Apertura	Policarbonato Material Carcasa
--	--------	------	-------------------------	--------	-------------	--------	---------	----------------------	--------------------------------

ATIK II
13DYDLED011VSCCTB

📄 Descargar Archivos

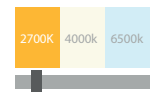

Selección de Temperatura con Switch



Dimerizable

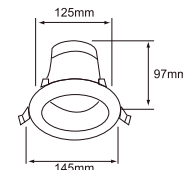

	Blanco	13 W	2700K 4000K 6500K	1015 lm	127 Voltaje	80 IRC	30.000h	90 Grado de Apertura	Policarbonato Material Carcasa
--	--------	------	-------------------------	---------	-------------	--------	---------	----------------------	--------------------------------

ATIK III
16DYDLED012VSCCTB

📄 Descargar Archivos

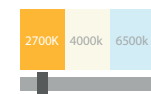

Selección de Temperatura con Switch



Dimerizable

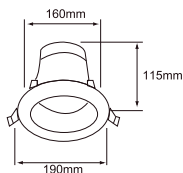

	Blanco	16 W	2700K 4000K 6500K	1480 lm	127 Voltaje	80 IRC	30.000h	90 Grado de Apertura	Policarbonato Material Carcasa
--	--------	------	-------------------------	---------	-------------	--------	---------	----------------------	--------------------------------

ATIK IV
20DYDLED013VSCCTB

📄 Descargar Archivos

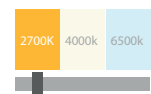

Selección de Temperatura con Switch



Dimerizable

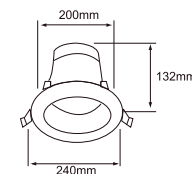

	Blanco	20 W	2700K 4000K 6500K	1880 lm	127 Voltaje	80 IRC	30.000h	90 Grado de Apertura	Policarbonato Material Carcasa
--	--------	------	-------------------------	---------	-------------	--------	---------	----------------------	--------------------------------



Cardans



LUCIDA I
3YDLED3161MV30B
3YDLED3161MV30N

Descargar Archivos



Mini Cardan

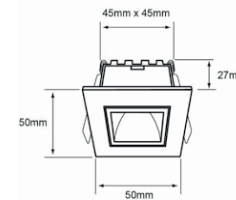

	Blanco Negro	3 W	3000K	115 lm	100-240 Voltaje	80 IRC	30.000h	34 Grado de Apertura	Aluminio Material Carcasa
--	-----------------	--------	-------	-----------	--------------------	-----------	---------	-------------------------	------------------------------

LUCIDA II
6YDLED3162MV30B
6YDLED3162MV30N

Descargar Archivos



Mini Cardan

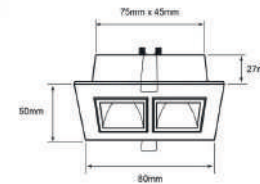

	Blanco Negro	6 W	3000K	235 lm	100-240 Voltaje	80 IRC	30.000h	34 Grado de Apertura	Aluminio Material Carcasa
--	-----------------	--------	-------	-----------	--------------------	-----------	---------	-------------------------	------------------------------

LUCIDA III
7YDLED3163MV30B
7YDLED3163MV30N

Descargar Archivos



Mini Cardan

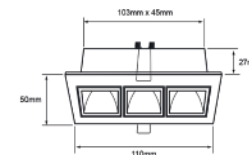

	Blanco Negro	7 W	3000K	305 lm	100-240 Voltaje	80 IRC	30.000h	34 Grado de Apertura	Aluminio Material Carcasa
--	-----------------	--------	-------	-----------	--------------------	-----------	---------	-------------------------	------------------------------

ALICANTE
60YD4001MVB
60YD4001MVN

Descargar Archivos

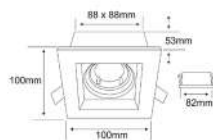

Incrustar Techo	Blanco Negro	GU10 No lo Incluye	Aluminio Material Carcasa
-----------------	-----------------	-----------------------	------------------------------

ALICANTE I
120YD4002MVB
120YD4002MVN

Descargar Archivos

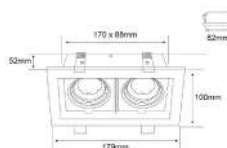

Incrustar Techo	Blanco Negro	GU10 X2 No lo Incluye	Aluminio Material Carcasa
-----------------	-----------------	--------------------------	------------------------------

ALICANTE II
180YD4003MVB
180YD4003MVN

Descargar Archivos

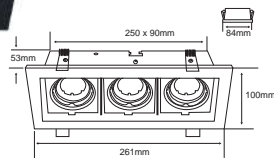

Incrustar Techo	Blanco Negro	GU10 X3 No lo Incluye	Aluminio Material Carcasa
-----------------	-----------------	--------------------------	------------------------------





NANCHONG
YD-700-1/N

[Descargar Archivos](#)



Dirigible

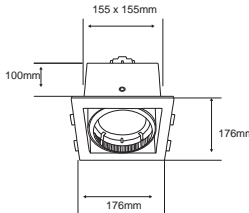

	Negro		Aluminio Material Carcasa
--	--------------	--	-------------------------------------

NANCHONG I
YD-700-2/N

[Descargar Archivos](#)



Dirigible

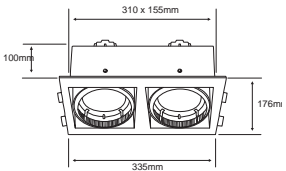

	Negro		Aluminio Material Carcasa
--	--------------	--	-------------------------------------

NANCHONG II
YD-700-3/N

[Descargar Archivos](#)



Dirigible

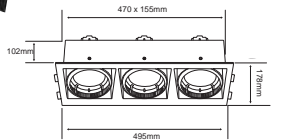

	Negro		Aluminio Material Carcasa
--	--------------	--	-------------------------------------





ARESE
YD-510/B

[Descargar Archivos](#)



Dirigible

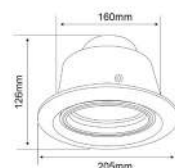

Blanco



Lámina de Acero
Material Carcasa

ARCO
YD-500-1/B

[Descargar Archivos](#)

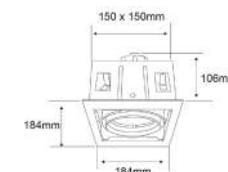

ALULA
20YD510MVBE27
20YD510MVNE27

[Descargar Archivos](#)



Dirigible

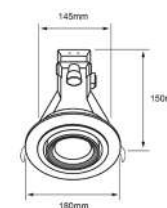

Blanco
Negro



Aluminio
Material Carcasa

Paneles



BRIGHTON VI
6YDLED431MV30B
6YDLED431MV65B

[Descargar Archivos](#)

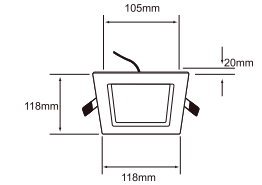

	Blanco	6 w	3000K 6500K	320 lm	100-240 Voltaje	70 IRC		120 Grado de Apertura	Aluminio Material Carcasa
--	--------	--------	----------------	-----------	--------------------	-----------	--	--------------------------	------------------------------

BRIGHTON VII
12YDLED431MV30B
12YDLED431MV65B

[Descargar Archivos](#)

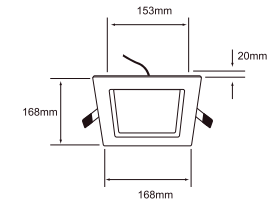

	Blanco	12 w	3000K 6500K	720 lm	100-240 Voltaje	70 IRC		120 Grado de Apertura	Aluminio Material Carcasa
--	--------	---------	----------------	-----------	--------------------	-----------	--	--------------------------	------------------------------

BRIGHTON VIII
18YDLED431MV30B
18YDLED431MV65B

[Descargar Archivos](#)

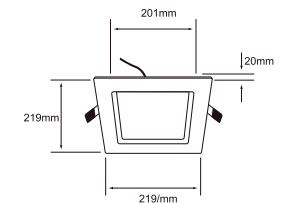

	Blanco	18 w	3000K 6500K	1200 lm	100-240 Voltaje	70 IRC		120 Grado de Apertura	Aluminio Material Carcasa
--	--------	---------	----------------	------------	--------------------	-----------	--	--------------------------	------------------------------

BUCARAMANGA VI
 6YDLED430MV30B
 6YDLED430MV40B
 6YDLED430MV65B

[Descargar Archivos](#)

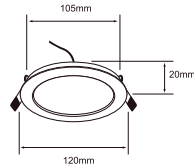

	Blanco	6 W	3000K 4000K 6500K	320 lm	100-240 Voltaje	70 IRC	 15.000h	120 Grado de Apertura	Aluminio Material Carcasa
--	--------	--------	-------------------------	-----------	--------------------	-----------	-------------	--------------------------	------------------------------

BUCARAMANGA VII
 12YDLED430MV30B
 12YDLED430MV40B
 12YDLED430MV65B

[Descargar Archivos](#)

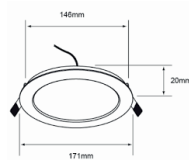

	Blanco	12 W	3000K 4000K 6500K	720 lm	100-240 Voltaje	70 IRC	 15.000h	120 Grado de Apertura	Aluminio Material Carcasa
--	--------	---------	-------------------------	-----------	--------------------	-----------	-------------	--------------------------	------------------------------

BUCARAMANGA VIII
 18YDLED430MV30B
 18YDLED430MV40B
 18YDLED430MV65B

[Descargar Archivos](#)

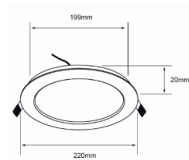

	Blanco	18 W	3000K 4000K 6500K	1200 lm	100-240 Voltaje	70 IRC	 15.000h	120 Grado de Apertura	Aluminio Material Carcasa
--	--------	---------	-------------------------	------------	--------------------	-----------	-------------	--------------------------	------------------------------

BUCARAMANGA IX
 24YDLED430MV30B
 24YDLED430MV65B

[Descargar Archivos](#)

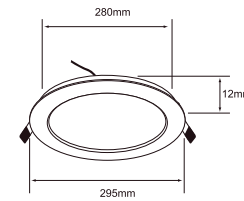

	Blanco	24 W	3000K 6500K	1600 lm	100-240 Voltaje	80 IRC	 15.000h	150 Grado de Apertura	Aluminio Material Carcasa
--	--------	---------	----------------	------------	--------------------	-----------	-------------	--------------------------	------------------------------





ALGEDI I
6PTLLEDC30MVB
6PTLLEDC65MVB

[Descargar Archivos](#)

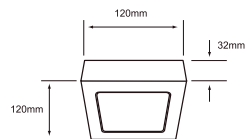

	Blanco	6 w	3000K 6500K	320lm 350lm	100-240 Voltaje	80 IRC		100 Grado de Apertura	Aluminio Material Carcasa
--	--------	--------	----------------	----------------	--------------------	-----------	--	--------------------------	------------------------------

ALGEDI II
12PTLLEDC30MVB
12PTLLEDC65MVB

[Descargar Archivos](#)

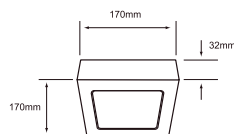

	Blanco	12 w	3000K 6500K	720lm 800lm	100-240 Voltaje	80 IRC		100 Grado de Apertura	Aluminio Material Carcasa
--	--------	---------	----------------	----------------	--------------------	-----------	--	--------------------------	------------------------------

ALGEDI III
18PTLLEDC30MVB
18PTLLEDC65MVB

[Descargar Archivos](#)

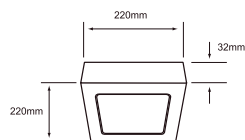

	Blanco	18 w	3000K 6500K	1200lm 1300lm	100-240 Voltaje	80 IRC		100 Grado de Apertura	Aluminio Material Carcasa
--	--------	---------	----------------	------------------	--------------------	-----------	--	--------------------------	------------------------------

ALGEDI IV
24PTLLEDC65MVB

[Descargar Archivos](#)

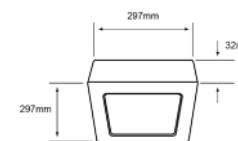
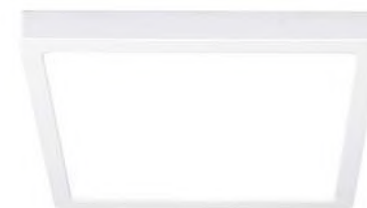

	Blanco	24 w	6500K	1600 lm	100-240 Voltaje	80 IRC		150 Grado de Apertura	Aluminio Material Carcasa
--	--------	---------	-------	------------	--------------------	-----------	--	--------------------------	------------------------------

ANKAA I
6PTLLEDR30MVB
6PTLLEDR65MVB

[Descargar Archivos](#)

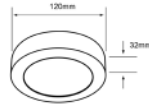

	Blanco	6 W	3000K 6500K	320lm 350lm	100-240 Voltaje	80 IRC	15.000h	100 Grado de Apertura	Aluminio Material Carcasa
--	--------	--------	----------------	----------------	--------------------	-----------	---------	--------------------------	------------------------------

ANKAA II
12PTLLEDR30MVB
12PTLLEDR65MVB

[Descargar Archivos](#)

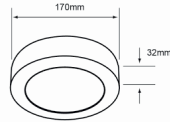

	Blanco	12 W	3000K 6500K	720lm 800lm	100-240 Voltaje	80 IRC	15.000h	100 Grado de Apertura	Aluminio Material Carcasa
--	--------	---------	----------------	----------------	--------------------	-----------	---------	--------------------------	------------------------------

ANKAA III
18PTLLEDR30MVB
18PTLLEDR65MVB

[Descargar Archivos](#)

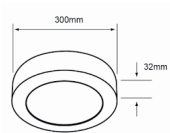

	Blanco	18 W	3000K 6500K	1200lm 1300lm	100-240 Voltaje	80 IRC	15.000h	100 Grado de Apertura	Aluminio Material Carcasa
--	--------	---------	----------------	------------------	--------------------	-----------	---------	--------------------------	------------------------------

ANKAA IV
24PTLLEDR65MVB

[Descargar Archivos](#)

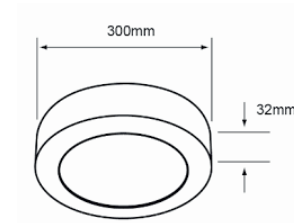

	Blanco	24 W	6500K	1600 lm	100-240 Voltaje	80 IRC	15.000h	150 Grado de Apertura	Aluminio Material Carcasa
--	--------	---------	-------	------------	--------------------	-----------	---------	--------------------------	------------------------------



Spots



BEID I
7YSNLED005MV30B
7YSNLED005MV30N

[Descargar Archivos](#)



	Blanco Negro	7 W	3000K	440 lm	100-240 Voltaje	80 IRC	 30.000h	30 Grado de Apertura	Aluminio Material Carcasa
--	-----------------	--------	-------	-----------	--------------------	-----------	-------------	-------------------------	------------------------------

HALLEY I
YSNLED-013/B
YSNLED-013/N

[Descargar Archivos](#)



	Blanco Negro	14.5 W	3000K	1200 lm	100-240 Voltaje	80 IRC	 20.000h	38 Grado de Apertura	Aluminio Material Carcasa
--	-----------------	-----------	-------	------------	--------------------	-----------	-------------	-------------------------	------------------------------

INDUS I
22YSNLED019MV30B
22YSNLED019MV30N

[Descargar Archivos](#)



Dirigible

	Blanco Negro	22 W	3000K	2200 lm	100-240 Voltaje	80 IRC	 20.000h	38 Grado de Apertura	Plástico Material Carcasa
--	-----------------	---------	-------	------------	--------------------	-----------	-------------	-------------------------	------------------------------

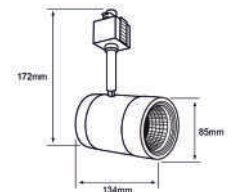

BELLAGIO I
YSN-367L/B
YSN-367L/N

[Descargar Archivos](#)

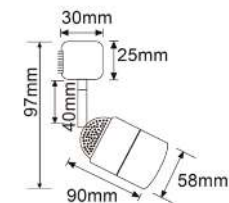

	Blanco Negro	 No lo Incluye	Aleación de Zinc Material Carcasa
--	------------------------	-------------------	--------------------------------------

BELLIZI
75YS395MVB
75YS395MVN

[Descargar Archivos](#)



	Blanco Negro	 No lo Incluye	Aleación de Zinc Material Carcasa
--	------------------------	-------------------	--------------------------------------

BELFORT
75YS397MVB
75YS397MVN

[Descargar Archivos](#)

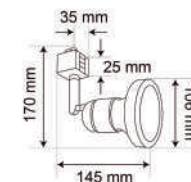

	Blanco Negro	 No lo Incluye	Aluminio Material Carcasa
--	------------------------	-------------------	------------------------------





AVOIR
60YS390MVB
60YS390MVN

[Descargar Archivos](#)

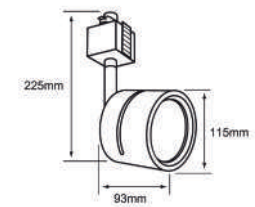

Blanco
Negro



Aluminio
Material
Carcasa

YS-100/B
YS-100/N

[Descargar Archivos](#)

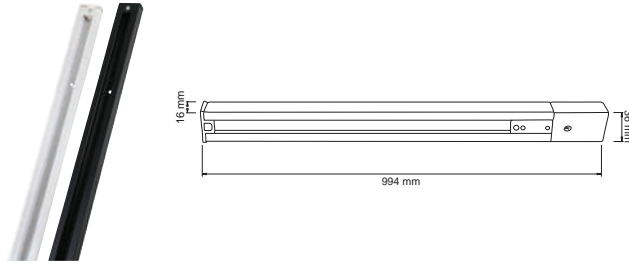

YS-200/B
YS-200/N

[Descargar Archivos](#)

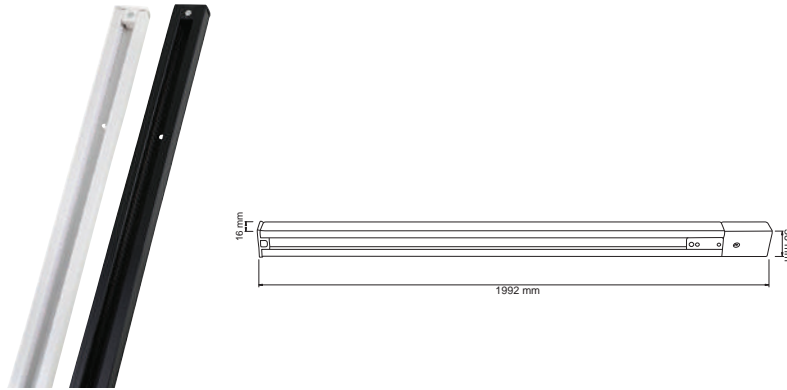

YS-I/B
YS-I/N

[Descargar Archivos](#)

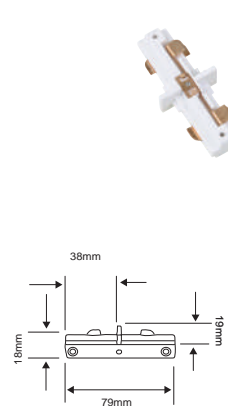

YS-L/B
YS-L/N

[Descargar Archivos](#)

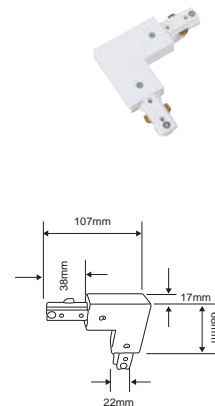



BEID II
7LVCLED005MV30B
7LVCLED005MV30N

[Descargar Archivos](#)

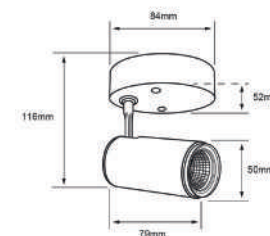

	Blanco Negro	7 W	3000K	440 lm	100-240 Voltaje	80 IRC	 30.000h	30 Grado de Apertura	Aluminio Material Carcasa
--	-----------------	--------	-------	-----------	--------------------	-----------	-------------	-------------------------	------------------------------

POLLUX
YSNLED-007/30/B
YSNLED-007/30/N

[Descargar Archivos](#)

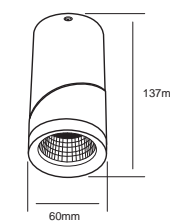

	Blanco Negro	6.5 W	3000K	570 lm	100-240 Voltaje	80 IRC	 15.000h	35 Grado de Apertura	Aluminio Material Carcasa
--	-----------------	----------	-------	-----------	--------------------	-----------	-------------	-------------------------	------------------------------

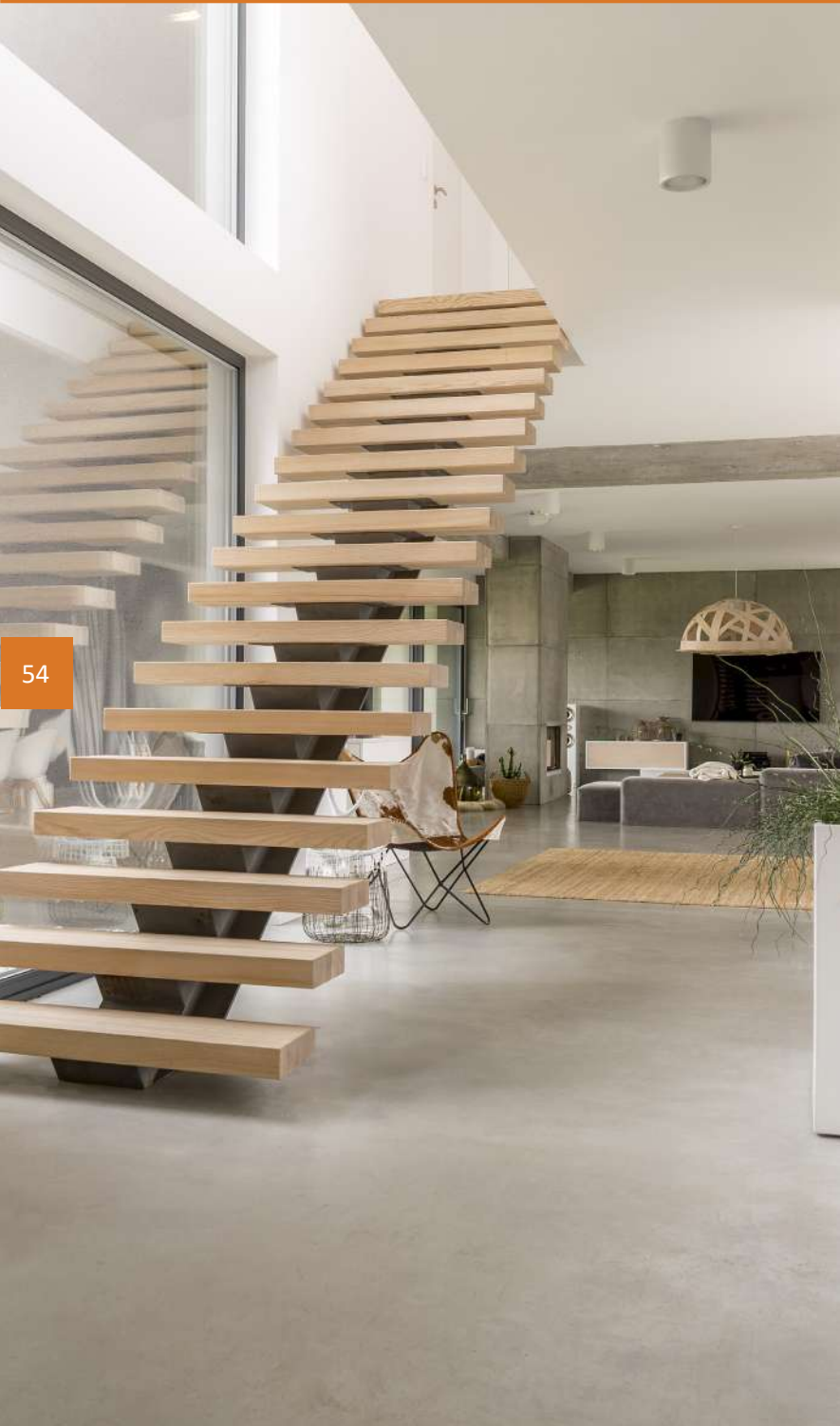

ASHLESHA
10YSNLED009MV30B
10YSNLED009MV30N

[Descargar Archivos](#)



Dirigible

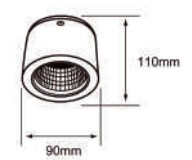

	Blanco Negro	10 W	3000K	1020 lm	100-240 Voltaje	80 IRC	 30.000h	36 Grado de Apertura	Aluminio Material Carcasa
--	-----------------	---------	-------	------------	--------------------	-----------	-------------	-------------------------	------------------------------

ASHLESHA I
20DYSNLED009V30B
20DYSNLED009V30N

[Descargar Archivos](#)



Dimerizable

Dirigible

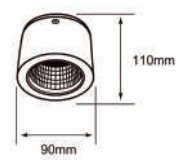

	Blanco Negro	20 W	3000K	1850 lm	127 Voltaje	80 IRC	 30.000h	36 Grado de Apertura	Aluminio Material Carcasa
--	-----------------	---------	-------	------------	----------------	-----------	-------------	-------------------------	------------------------------

PING
13PTLLED210MV30N

Descargar Archivos

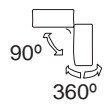

Dirigible

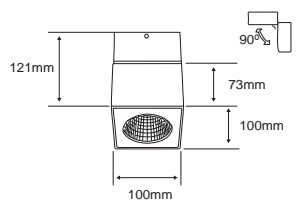

	Negro	13 W	3000K	950 lm	100-240 Voltaje	80 IRC	 30.000h	20 Grado de Apertura	Aluminio Material Carcasa
--	--------------	----------------	--------------	------------------	--------------------	------------------	--------------------	--------------------------------	-------------------------------------

PRAIA
PTLLED-209/24W/30B
24PTLLED209MV30N

Descargar Archivos

Descargar Archivos

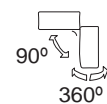

Dirigible

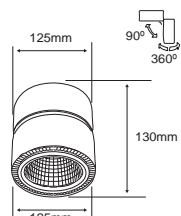

	Blanco Negro	24 W	3000K	1450 lm	100-240 Voltaje	80 IRC	 30.000h	20 Grado de Apertura	Aluminio Material Carcasa
--	-------------------------------	----------------	--------------	-------------------	--------------------	------------------	--------------------	--------------------------------	-------------------------------------

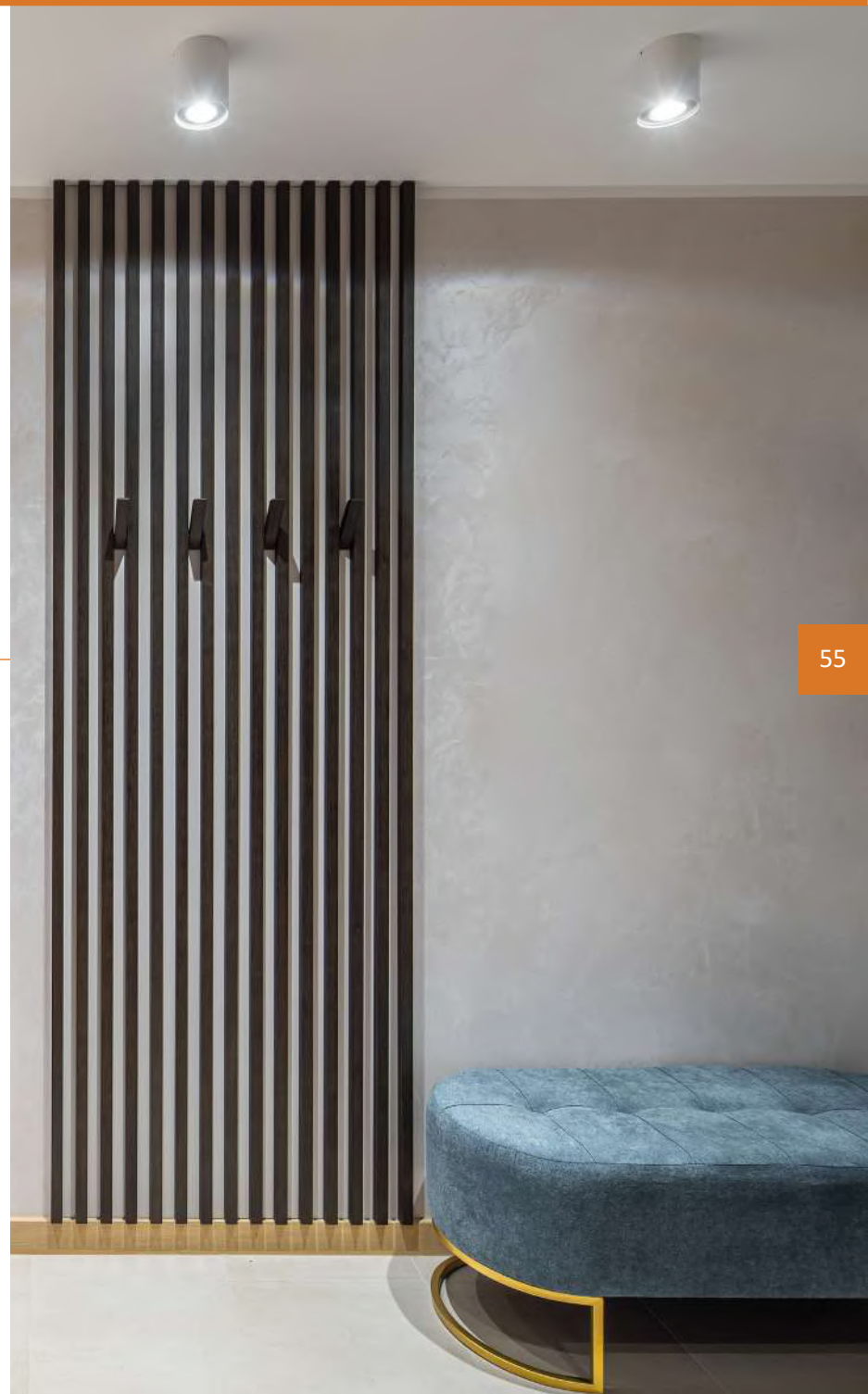



AMADIO
60YSN4024MVB

[Descargar Archivos](#)



Dirigible

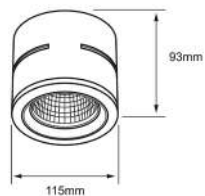

	Blanco		Aluminio Material Carcasa
--	--------	--	------------------------------

ALNASI II
60YSN4010MVB

[Descargar Archivos](#)



Dirigible

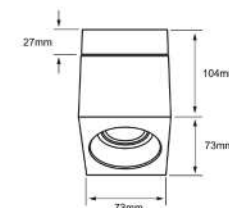

	Blanco		Aluminio Material Carcasa
--	--------	--	------------------------------

ALNASI I
60YSN4020MVB

[Descargar Archivos](#)



Dirigible

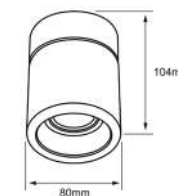

	Blanco		Aluminio Material Carcasa
--	--------	--	------------------------------

BELLGIO
60YSN368LMVB
60YSN368LMVN

[Descargar Archivos](#)



	Blanco Negro	 No lo Incluye	Aleación de Zinc Material Carcasa
--	-----------------	-------------------	--------------------------------------

AVOIR I
60YS391MVB
60YS391MVN

[Descargar Archivos](#)



	Blanco Negro	 No lo Incluye	Aluminio Material Carcasa
--	-----------------	-------------------	------------------------------

BELFORT I
75YS398MVB
75YS398MVN

[Descargar Archivos](#)



	Blanco Negro	 No lo incluye	Aluminio Material Carcasa
--	-----------------	-------------------	------------------------------

BREME I
YS-400/B
YS-400/N

[Descargar Archivos](#)



	Blanco Negro	 No lo incluye	Aluminio Material Carcasa
--	-----------------	-------------------	------------------------------



Plafones





LA CERTA
PTLLED-1110/40/B
PTLLED-1110/65/B

[Descargar Archivos](#)

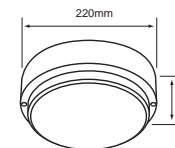

IP
65



 Incrustar Techo	Blanco	9 w	4000K 6500K	800 lm	100-240 Voltaje	80 IRC	 20.000h	115 Grado de Apertura	Polycarbonato Material Carcasa
--	--------	--------	----------------	-----------	--------------------	-----------	--	--------------------------	-----------------------------------



LA CERTA I
PTLLED-1120/40/B
PTLLED-1120/65/B

[Descargar Archivos](#)

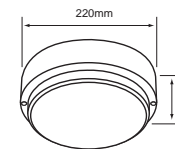

IP
65



 Incrustar Techo	Blanco	18 w	4000K 6500K	1500 lm	100-240 Voltaje	80 IRC	 20.000h	115 Grado de Apertura	Polycarbonato Material Carcasa
--	--------	---------	----------------	------------	--------------------	-----------	--	--------------------------	-----------------------------------

COLUMBUS
PTLELED/004/65/B

Descargar Archivos



Base E27

 *Instalación Directa al Socket*

 Sobreponer	Blanco	13 W	6500K	1100 lm	100-240 Voltaje	80 IRC	25.000h	100 Grado de Apertura	Plástico Material Carcasa
--	--------	---------	-------	------------	--------------------	-----------	---------	--------------------------	------------------------------

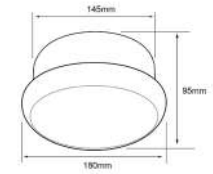

AUSTRAL
PTLLED/012/30
PTLLED/012/65

Descargar Archivos



 Sobreponer	Blanco	12 W	4000K	700lm	100-240 Voltaje	80 IRC	15.000h	100 Grado de Apertura	Plástico Material Carcasa
			6500K	800lm					

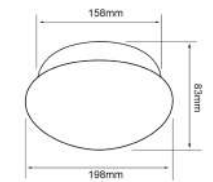

SATELITE II
PTLLED-005/30/N
[Descargar Archivos](#)

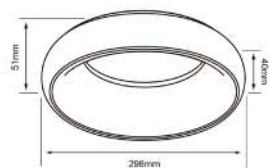

 Sobreponer	Negro	25 W	3000K	1800 lm	100-240 Voltaje	80 IRC	 40.000h	120 Grado de Apertura	Aluminio Material Carcasa
----------------	--------------	----------------	--------------	-------------------	--------------------	------------------	--------------------	---------------------------------	------------------------------

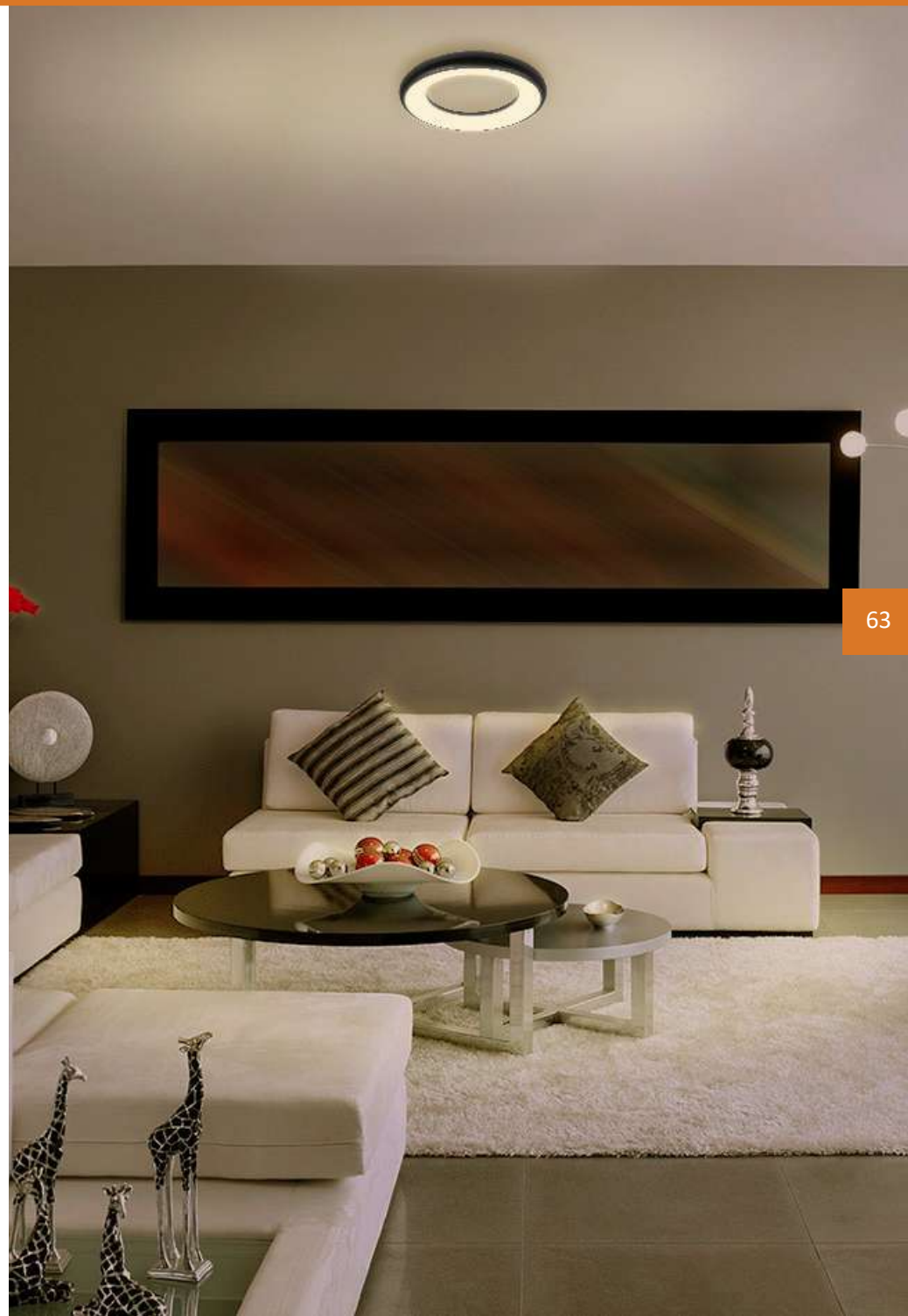

APLIQUES
DE *Pared*

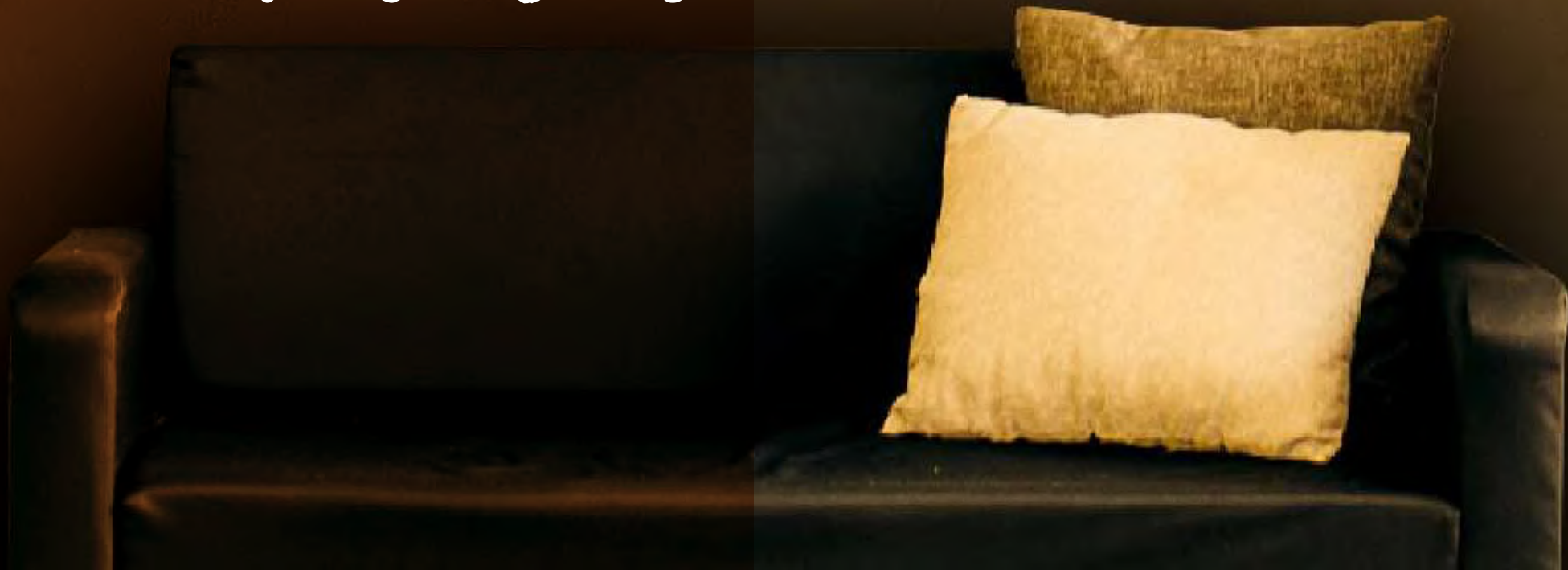

ALRESHA
5TLLED615MV30TG

[Descargar Archivos](#)

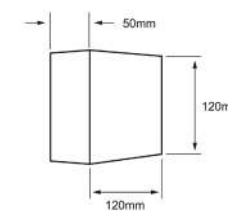
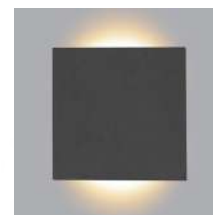

 Sobreponer Pared/Muro	Gris	5 W	3000K	318 lm	100-240 Voltaje	80 IRC	 25.000h	193 Grado de Apertura	Aluminio Material Carcasa
---------------------------	-------------	---------------	--------------	------------------	--------------------	------------------	--------------------	---------------------------------	-------------------------------------

GRUIS
20TLLED408MV30B
20TLLED408MV30N

[Descargar Archivos](#)

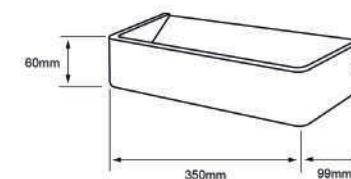

 Sobreponer Pared/Muro	Blanco Negro	20 W	3000K	1100 lm	100-240 Voltaje	80 IRC	 30.000h	155 Grado de Apertura	Aluminio Material Carcasa
---------------------------	-------------------------------	----------------	--------------	-------------------	--------------------	------------------	--------------------	---------------------------------	-------------------------------------

JUXTA I
10TLED612MV30N

[Descargar Archivos](#)

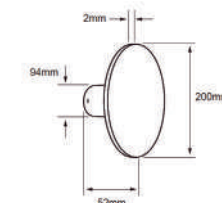

	Negro	10 W	3000K	690 lm	100-240 Voltaje	80 IRC		100 Grado de Apertura	Aluminio Material Carcasa
--	--------------	----------------	--------------	------------------	--------------------	------------------	--	---------------------------------	-------------------------------------

JUXTA II
15TLED613MV30N

[Descargar Archivos](#)

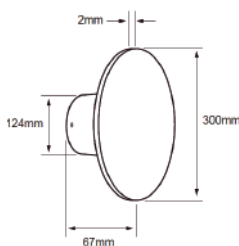

	Negro	15 W	3000K	1300 lm	100-240 Voltaje	80 IRC		100 Grado de Apertura	Aluminio Material Carcasa
--	--------------	----------------	--------------	-------------------	--------------------	------------------	--	---------------------------------	-------------------------------------

JUXTA III
20TLED614MV30N

[Descargar Archivos](#)

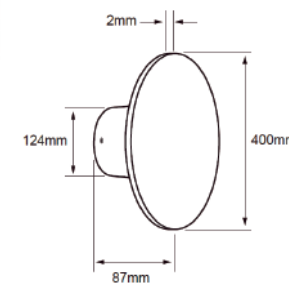

	Negro	20 W	3000K	1500 lm	100-240 Voltaje	80 IRC		100 Grado de Apertura	Aluminio Material Carcasa
--	--------------	----------------	--------------	-------------------	--------------------	------------------	--	---------------------------------	-------------------------------------

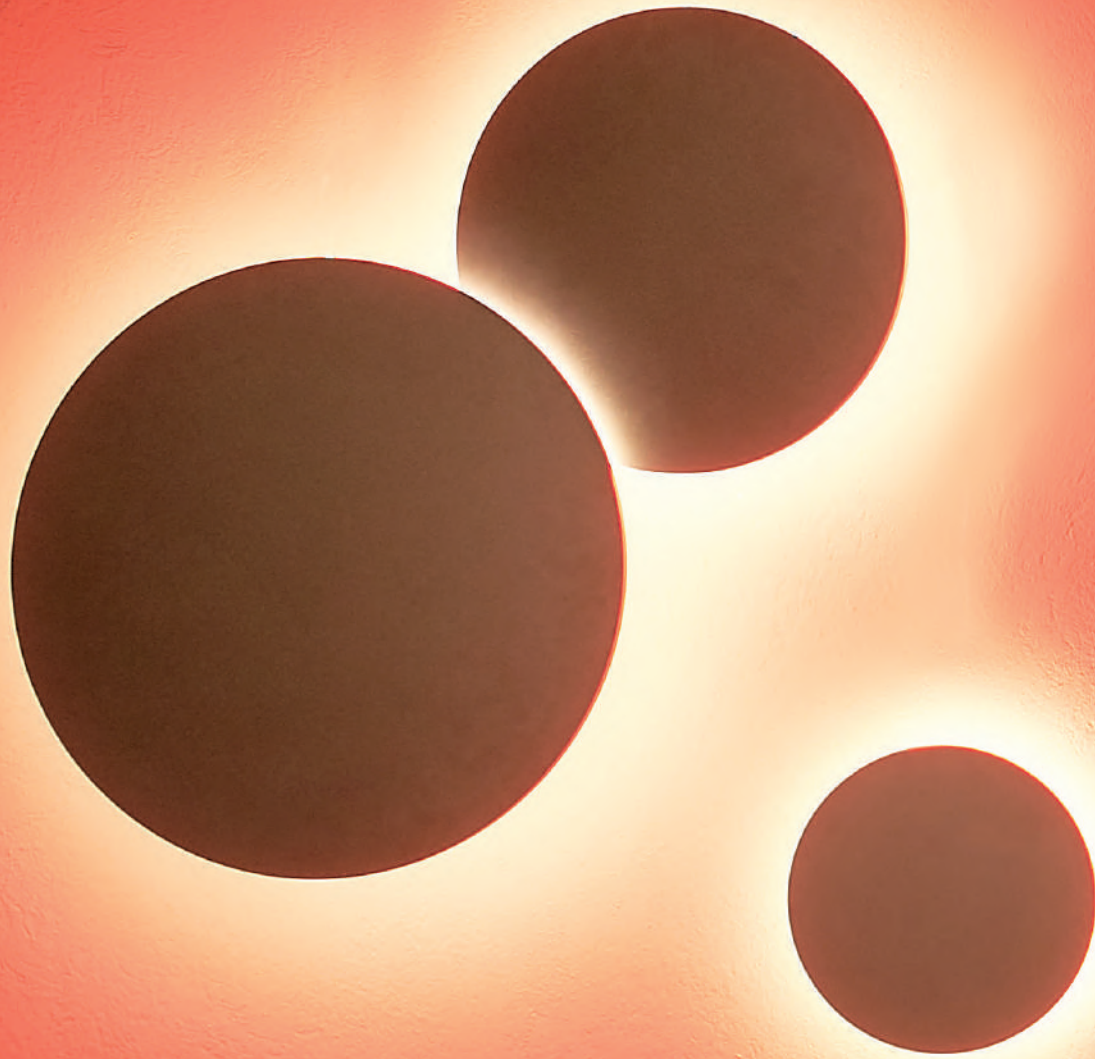



FAIS
TLLED-405/10W/30B

[Descargar Archivos](#)

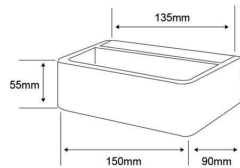

	Blanco	10 W	3000K	450 lm	100-240 Voltaje	80 IRC	25.000h	155 Grado de Apertura	Aluminio Material Carcasa
--	--------	---------	-------	-----------	--------------------	-----------	---------	--------------------------	------------------------------

FUYU
TLLED-401/5.5W/30B

[Descargar Archivos](#)

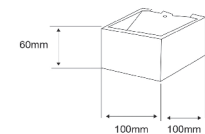

	Blanco	5.5 W	3000K	250 lm	100-240 Voltaje	80 IRC	20.000h	154 Grado de Apertura	Aluminio Material Carcasa
--	--------	----------	-------	-----------	--------------------	-----------	---------	--------------------------	------------------------------

FUJIAN
TLLED-402/7W/30B

[Descargar Archivos](#)

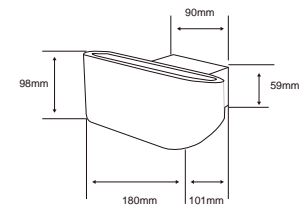

	Blanco	7 W	3000K	450 lm	100-240 Voltaje	80 IRC	25.000h	132 Grado de Apertura	Aluminio Material Carcasa
--	--------	--------	-------	-----------	--------------------	-----------	---------	--------------------------	------------------------------

CANCRI
TLLED-407/30/N

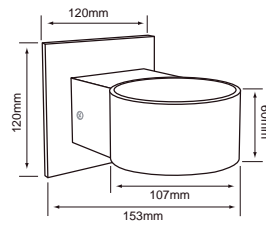

Descargar Archivos

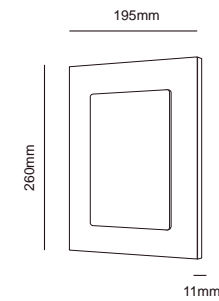

ABEERDINE
TLLED-600/B

Descargar Archivos



 Sobreponer Pared/Muro	Negro	5.5 W	3000K	315 lm	100-240 Voltaje	80 IRC	 25.000h	40 Grado de Apertura	Aluminio Material Carcasa
--	--------------	-----------------	--------------	------------------	--------------------	------------------	---	--------------------------------	-------------------------------------

 Sobreponer Pared/Muro	Blanco	10 W	3000K	700 lm	100-127 Voltaje	80 IRC	 25.000h	120 Grado de Apertura	Aleación de Acero Material Carcasa
--	---------------	----------------	--------------	------------------	--------------------	------------------	---	---------------------------------	--





GENOVA
60TL1860MVOP

[Descargar Archivos](#)

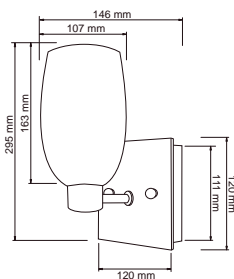

Cristal Opalino



Cristal
Material
Carcasa

CONCORDIA
60TL6020MVOP

[Descargar Archivos](#)

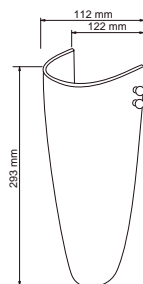

Cristal Opalino



Cristal
Material
Carcasa

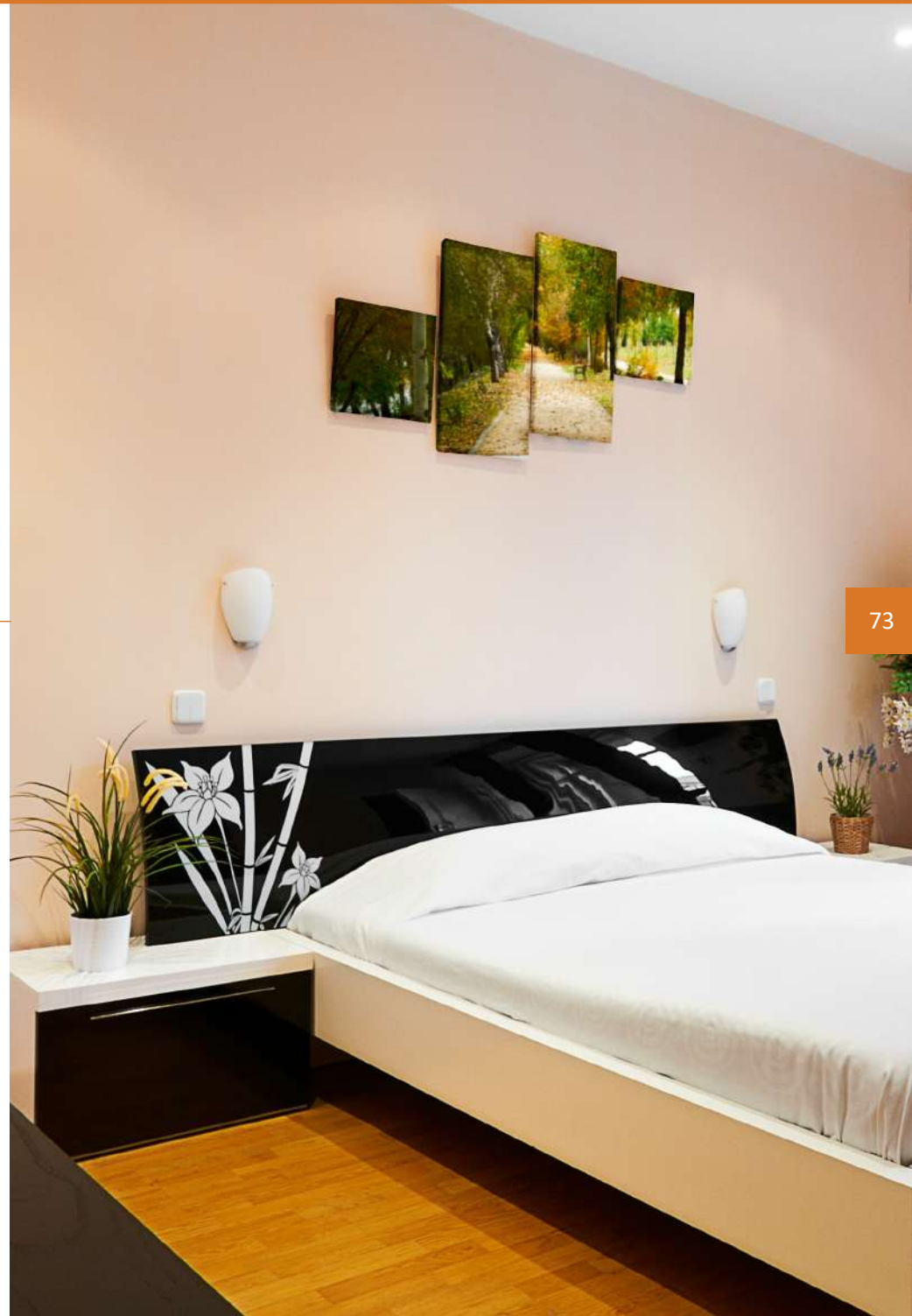



CYNARA
3ETLLED001MV30B
3ETLLED001MV30N

[Descargar Archivos](#)

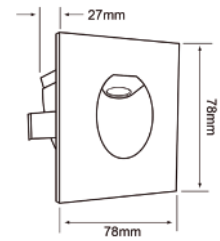
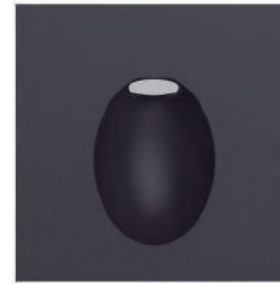

	Blanco Negro	3 W	3000K	125 lm	100-240 Voltaje	80 IRC	50.000h	36 Grado de Apertura	Aluminio Material Carcasa
--	-----------------	--------	-------	-----------	--------------------	-----------	---------	-------------------------	------------------------------

CYRANO
3ETLLED002MV30B
3ETLLED002MV30N

[Descargar Archivos](#)

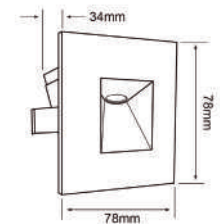

	Blanco Negro	3 W	3000K	125 lm	100-240 Voltaje	80 IRC	50.000h	36 Grado de Apertura	Aluminio Material Carcasa
--	-----------------	--------	-------	-----------	--------------------	-----------	---------	-------------------------	------------------------------

Colgantes



EPSILON
CTLLED-152/30/B
CTLLED-152/30/N

[Descargar Archivos](#)

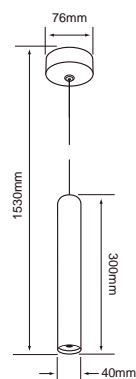

Suspend	Blanco Negro	3 W	3000K	210 lm	100-240 Voltaje	80 IRC	15.000h	10 Grado de Apertura	Aluminio Material Carcasa
---------	-----------------	--------	-------	-----------	--------------------	-----------	---------	-------------------------	------------------------------

SATELITE
CTLLED-005/30/N

[Descargar Archivos](#)

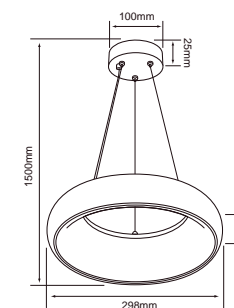
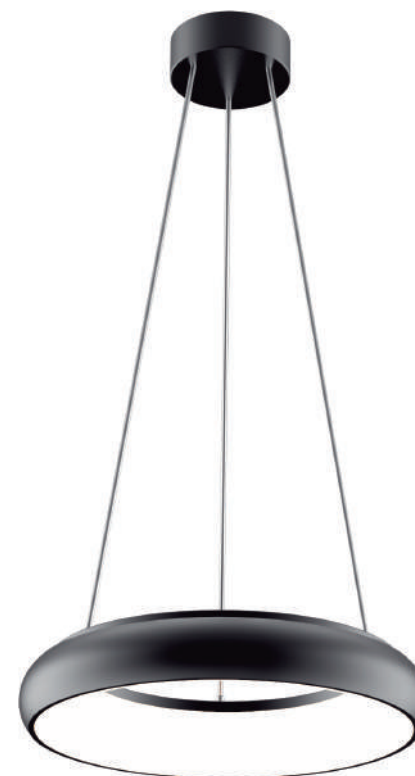





Suspend	Negro	25 W	3000K	1800 lm	100-240 Voltaje	80 IRC	40.000h	120 Grado de Apertura	Aluminio Material Carcasa
---------	-------	---------	-------	------------	--------------------	-----------	---------	--------------------------	------------------------------

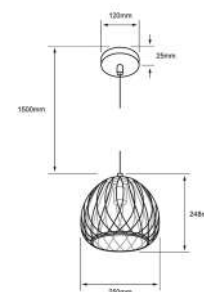

KOEIA II
60CTL6124MVN
[Descargar Archivos](#)



 Suspender	 Negro	 No lo incluye	 Lámina de Acero Material Carcasa
--	--	--	--

APODIS
20CTL8183MVCH

[Descargar Archivos](#)

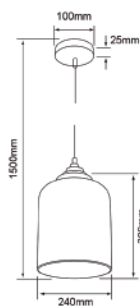

Suspend	Humo	No lo Incluye	Lámina de Acero Material Carcasa
---------	------	---------------	-------------------------------------

ARIETIS
20CTL8184MVCH

[Descargar Archivos](#)

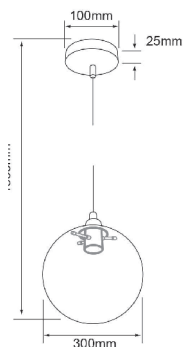

Suspend	Humo	No lo Incluye	Lámina de Acero Material Carcasa
---------	------	---------------	-------------------------------------

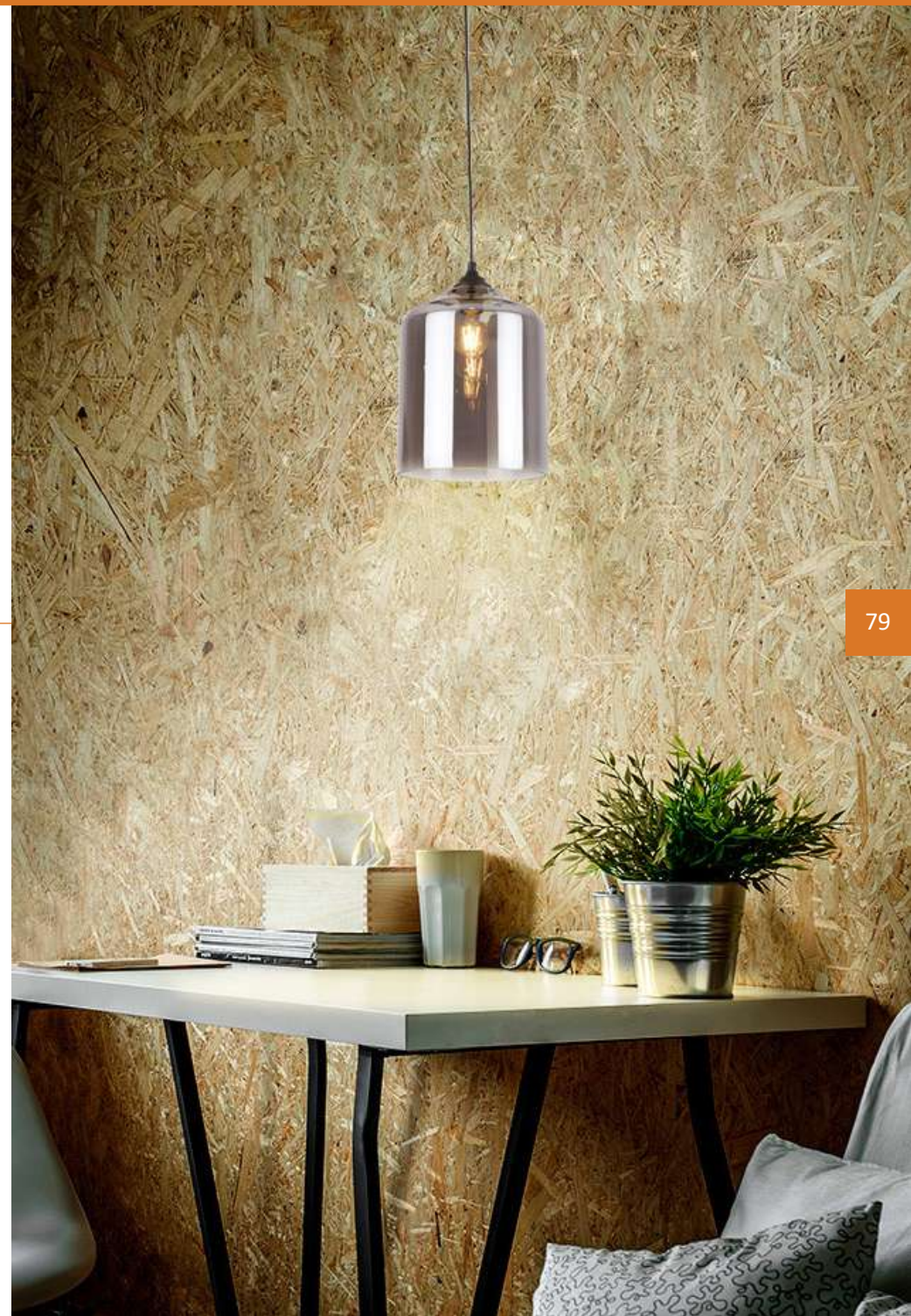

LAOS I
60CTL8176MVC
[Descargar Archivos](#)

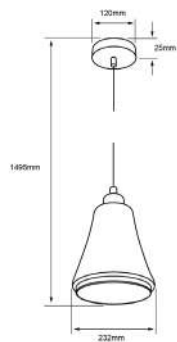

 Suspend	 Transparente	 No lo Incluye	 Lámina de Acero Material Carcasa
--	---	--	--

ARTEMISA I
60CTL8177MVC

Descargar Archivos

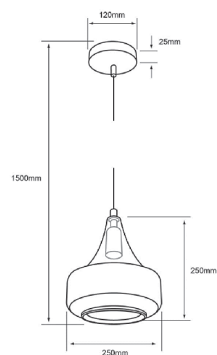

 Suspend	 Transparente	 No lo Incluye	 Lámina de Acero Material Carcasa
--	---	--	--





ELECTRA
60CTL8212MVPL
[Descargar Archivos](#)

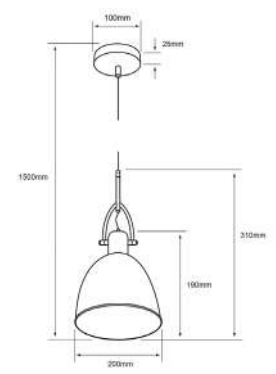

- Suspendir
- Acero
- No lo incluye
- Lámina de Acero
Material Cárcasa

AUVA
CTL-7432/B
CTL-7432/N
[Descargar Archivos](#)

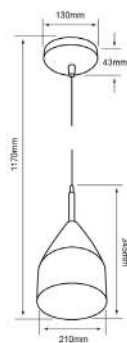

Suspenders	Blanco Negro	E27 No lo Incluye	Aluminio Material Carcasa
------------	-----------------	----------------------	---------------------------------

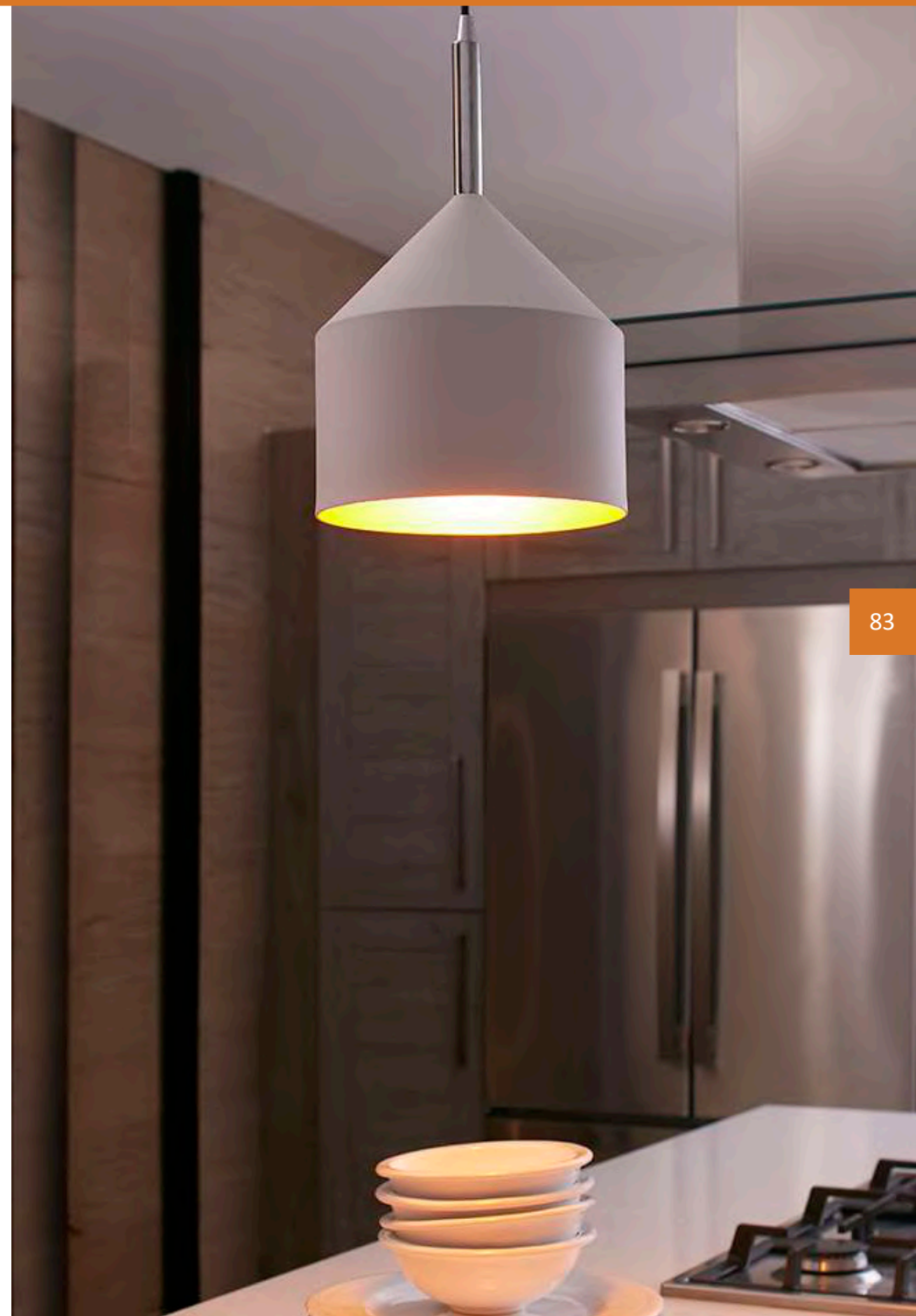

Oficina



DOMUS IV
40PANLED40MVB
40PANLED65MVB

[Descargar Archivos](#)

.Accesorios se venden por separado
A40PANLEDMVS

[Descargar Archivos](#)



2en1
 Incrustar
 y Suspender

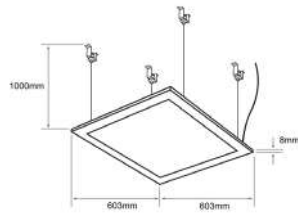

 Incrustar y Suspender	Blanco	40 w	4000K 6500K	3000 lm	100-240 Voltaje	70 IRC	 25.000h	120 Grado de Apertura	Aluminio Material Carcasa
---------------------------	--------	---------	----------------	------------	--------------------	-----------	-------------	--------------------------	------------------------------







ACRUX
40BKLED65MVB
[Descargar Archivos](#)

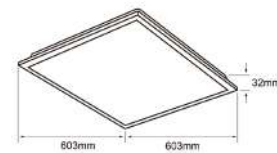

Mayor
Flujo Lumínico



 Incrustar Techo	Blanco	40 W	6500K	3800 lm	100-240 Voltaje	80 IRC	 30.000h	120 Grado de Apertura	Lámina de Acero Material Carcasa
---	--------	---------	-------	------------	--------------------	-----------	--	-----------------------------	---

DOMUS I
PAN-LED/40/40/S
PAN-LED/40/65/S

[Descargar Archivos](#)

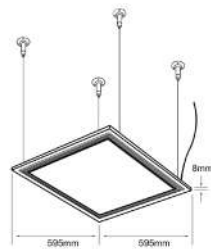
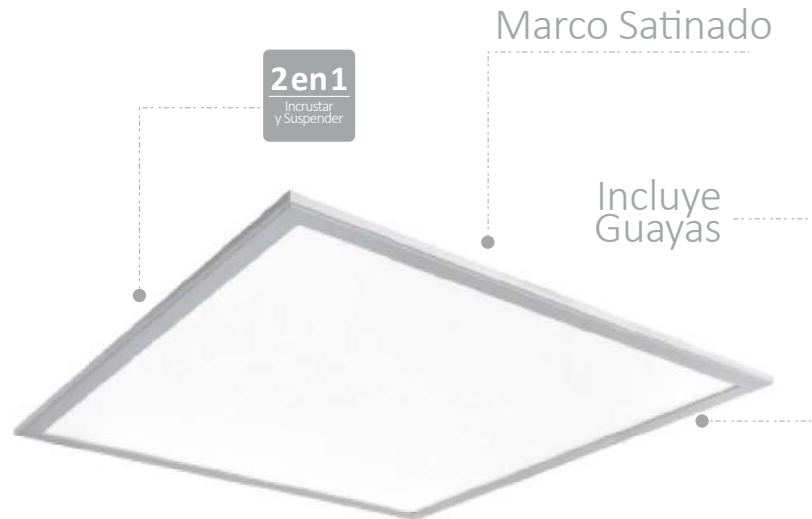

 Incrustar y Suspender	Satinado	40 w	4000K 6500K	3500 lm	100-240 Voltaje	80 IRC	 25.000h	120 Grado de Apertura	Aluminio Material Carcasa
---------------------------	----------	---------	----------------	------------	--------------------	-----------	-------------	--------------------------	------------------------------



DOMUS II
PAN-LED-L/45/40/S

[Descargar Archivos](#)



2en1

Incrustar
y Suspender

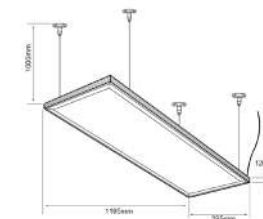

Satinado

45
W

4000K

3600
lm

100-240
Voltaje

80
IRC

25.000h

110
Grado de
Apertura

Aluminio
Material
Carcasa

DOMUS III
PAN-LED/60/40/S

[Descargar Archivos](#)



2en1

Incrustar
y Suspender

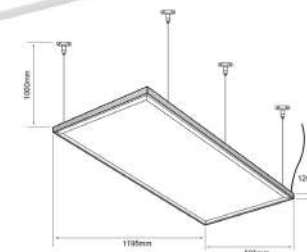

Satinado

60
W

4000K

5400
lm

100-240
Voltaje

80
IRC

25.000h

110
Grado de
Apertura

Aluminio
Material
Carcasa

NASHVILLE
PAN-LED/R40/40

[Descargar Archivos](#)

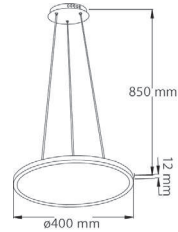

Suspend	Blanco	24 W	4000K	2000 lm	100-240 Voltaje	80 IRC	25.000h	120 Grado de Apertura	Aluminio Material Carcasa
---------	--------	---------	-------	------------	--------------------	-----------	---------	--------------------------	------------------------------

NASHVILLE I
PAN-LED/R60/40

[Descargar Archivos](#)

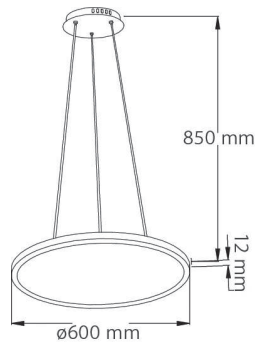

Suspend	Blanco	36 W	4000K	2200 lm	100-240 Voltaje	80 IRC	25.000h	120 Grado de Apertura	Aluminio Material Carcasa
---------	--------	---------	-------	------------	--------------------	-----------	---------	--------------------------	------------------------------





Lineales

OF4250BBCA
OF4250BBNA
CONSTRULITA
Descargar Archivos



Interconectable
Fácil Instalación



*Módulo base funciona para tres formas de aplicación.
Empotrar / Suspender / Sobreponer

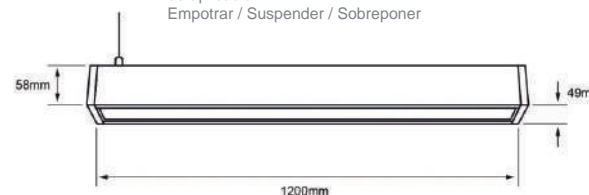

Sobreponer, Suspender e Incrustar	Negro	38 W	3000K / 4000K	4000 lm	100-277 Voltaje	80 IRC	50.000h	100 Grado de Apertura	Aluminio Plástico Material Carcasa
-----------------------------------	--------------	------	---------------	---------	-----------------	--------	---------	-----------------------	------------------------------------

UNIONES

AC4251BBCA
AC4251BBNA
CONSTRULITA

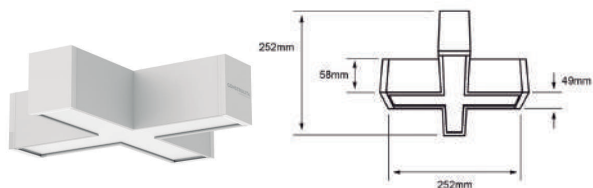

AC4252BBCA
AC4252BBNA
CONSTRULITA

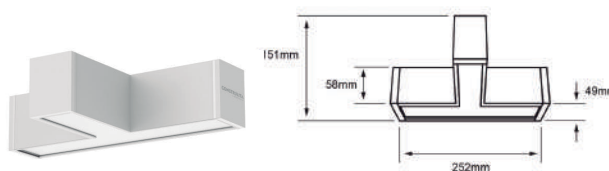

AC4253BBCA
AC4253BBNA
CONSTRULITA

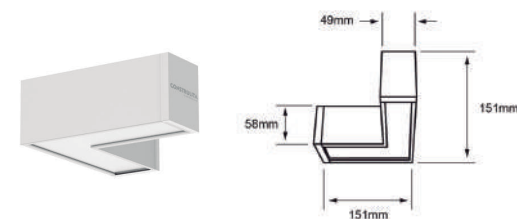

ACCESORIOS

AC4256S
CONSTRULITA

Sobreponer

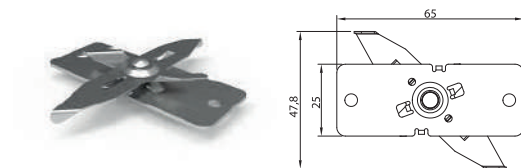

AC8254S
CONSTRULITA

Suspender

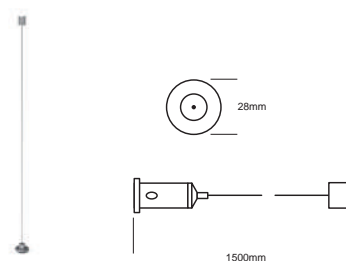

AC1255S
CONSTRULITA

Empotrar

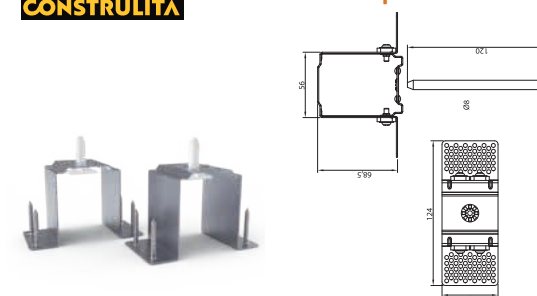

OF4250NBCA
OF4250NBNA

CONSTRULITA

Descargar Archivos



Interconectable
Fácil Instalación



*Módulo base funciona para tres formas de aplicación.
Empotrar / Suspender / Sobreponer

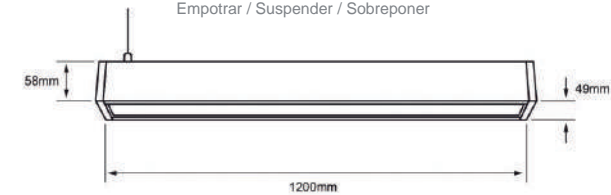

Sobreponer, Suspender e Incrustar	Negro	38 W	3000K 4000K	4000 lm	100-277 Voltaje	80 IRC	50.000h	100 Grado de Apertura	Aluminio Plástico Material Carcasa
---	-------	---------	----------------	------------	--------------------	-----------	---------	-----------------------------	---

UNIONES

AC4251NBCA
AC4251NBNA

CONSTRULITA

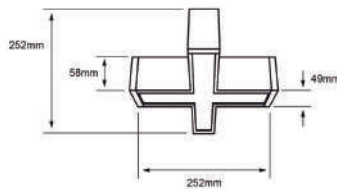

AC4252NBCA
AC4252NBNA

CONSTRULITA

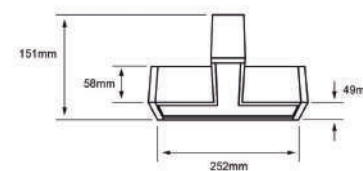

AC4253NBCA
AC4253NBNA

CONSTRULITA

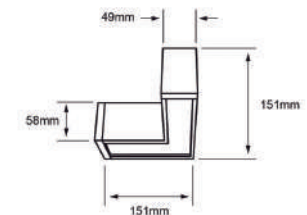

ACCESORIOS

Para Sobreponer

AC4256S

CONSTRULITA

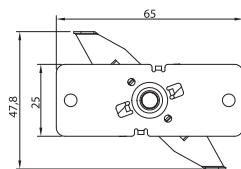

Para Suspensión

AC8254S

CONSTRULITA

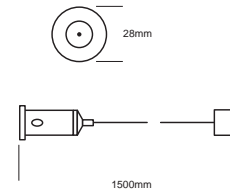

Para Empotrar

AC1255S

CONSTRULITA

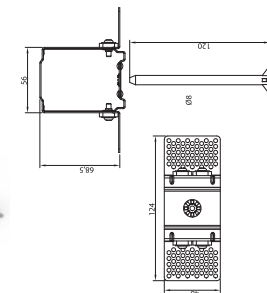





NEIVA III
32LFCLED2202V40S

[Descargar Archivos](#)

Incluye
2 Tubos T5



Suspendir	Satinado	32 W	4000K	3000 lm	127 Voltaje	80 IRC	15.000h	100 Grado de Apertura	Aluminio Material Carcasa
-----------	----------	---------	-------	------------	----------------	-----------	---------	--------------------------	------------------------------

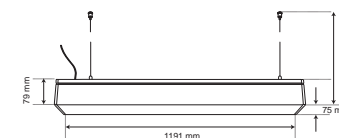

NAGOYA II
40DLFCLED1282V40B
40DLFCLED1282V40N

[Descargar Archivos](#)

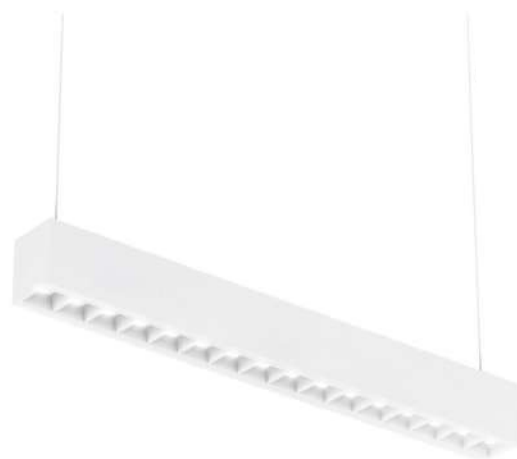

Suspendir	Blanco Negro	40 W	4000K	4500 lm	127 Voltaje	80 IRC	30.000h	100 Grado de Apertura	Aluminio Material Carcasa
-----------	-----------------	---------	-------	------------	----------------	-----------	---------	--------------------------	------------------------------

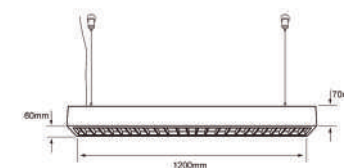



CINTAS
Lead

MEDITERRANEAN
CADE

江南环球港
双喜队
莱斯周年
环球运动嘉年华



TIRA LED COB BAJO VOLTAJE
TLED-COB-10W/BC
TLED-COB-10W/BN
TLED-COB-10W/LD

[Descargar Archivos](#)



Compatible con controlador



Dimerizable



Corte cada 5 cms

5 METROS	6W/m 30W/5m W	3000K 4000K 6500K	1000 lm	24v	180 Ángulo de iluminación	20 IP
-------------	---------------------	-------------------------	------------	-----	---------------------------------	----------



CINTA CON CONTROLADOR DE TEMPERATURA DE COLOR
TL-CM-5M

[Descargar Archivos](#)



 **KIT completo**
Presentación
en Blister

INCLUYE
Drive y Controlador de Color

30 Led x Metro
Corte cada 3 Leds

5 Metros	3000K 6500K	72w/m	120 Ángulo de iluminación	45 IP
-------------	----------------	-------	---------------------------------	----------

CINTA LED CON CONTROLADOR INFRAROJO
TL-RGB-CI

[Descargar Archivos](#)



 **KIT completo**
Presentación
en Blister

INCLUYE
Drive y Controlador de Color

30 Led x Metro
Corte cada 3 Leds

5 Metros	RGB	72w/m	120 Ángulo de iluminación	45 IP
-------------	-----	-------	---------------------------------	----------







Perfiles

PERFIL LINEAL SIN CUBIERTA
PLMX-250-1913-S-AL
PLMX-250-1913-S-NG

Descargar Archivos

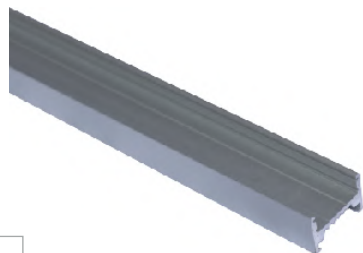

Suspender
y Sobreponer

Aluminio	2	Aluminio	20
Negro	METROS	Material Carcasa	IP

SOBREPONER CON GRAPA

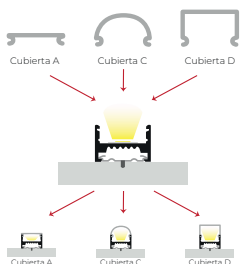

SOBREPONER CON IMÁN

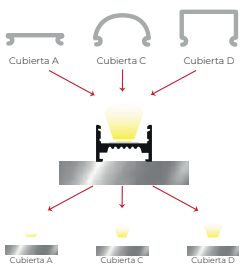

SUSPENDER

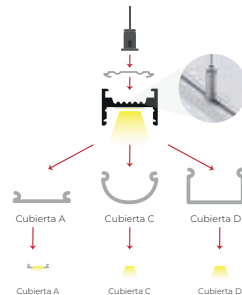

ACCESORIOS

CUBIERTAS

CUBIERTA VERSIÓN A - PLANA

PLMX-250-A-PCNG
PLMX-250-A-PC

Negro
Difusa

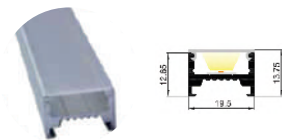

CUBIERTA VERSIÓN D - RECTANGULAR

PLMX-250-C-PC-N
PLMX-250-C-PC

Negro
Difusa

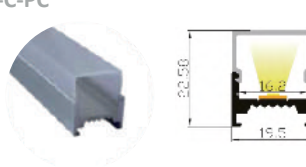

TAPAS

PLMX-250-1A-B

PLMX-250-1A-B



Tapa final para perfil con salida para cubierta A
Terminado: Plástico

PLMX-250-1A-N



Tapa final para perfil sin salida para cubierta A
Terminado: Plástico

PLMX-250-1A-N

PLMX-250-1R-B

PLMX-250-1R-B



Tapa final para perfil con salida para cubierta D
Terminado: Plástico

PLMX-250-1R-N



Tapa final para perfil sin salida para cubierta D
Terminado: Plástico

PLMX-250-1R-N

GUAYAS Y CONECTORES



PLMX-ACC-SP-LG
 Accesorio de suspensión para perfil

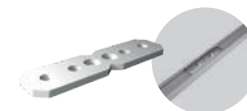

PLMX-250-1
 Conector recto para perfil
 Terminado: Metal



PLMX-250-3
 Conector a 90° vertical para perfil
 Terminado: Metal



PLMX-250-2
 Conector a 90° para perfil
 Terminado: Metal



PLMX-250-5
 Conector a 45° en vertical para perfil
 Terminado: Metal



PLMX-250-4
 Conector a 45° para perfil
 Terminado: Metal

**PERFIL LINEAL DE ALUMINIO
PLMX-250-6113-AL**

[Descargar Archivos](#)



Incrustar a Techo

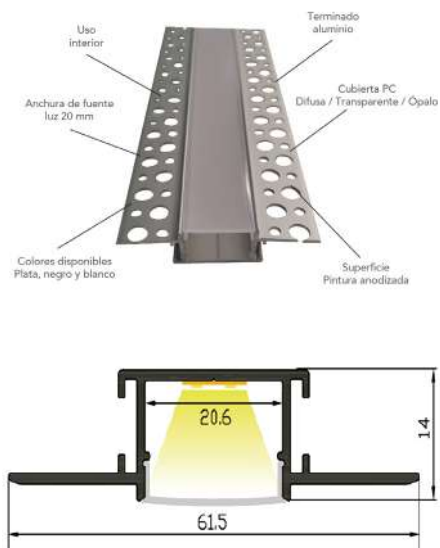

2	Aluminio	20
METROS	Material Corcusa	IP

INSTALACIÓN

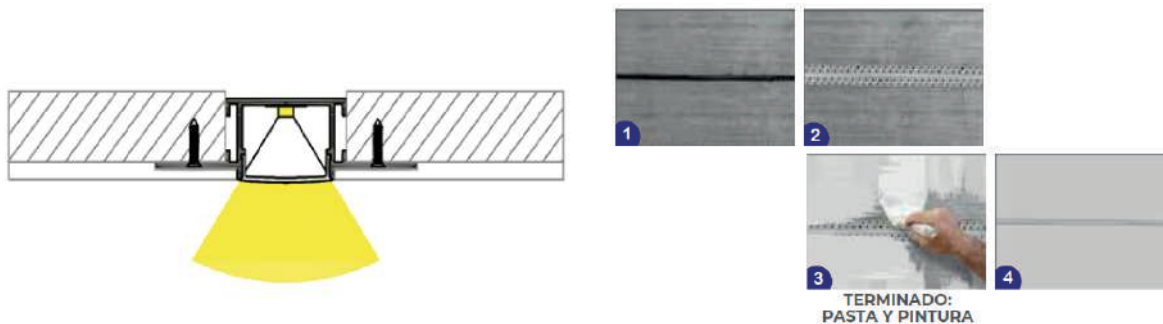

ACCESORIOS



PLMX-250-1A-B
Tapa final para perfil de aluminio empotrado interior con salida
Terminado: Plástico



PLMX-250-1A-B
Tapa final para perfil de aluminio empotrado interior sin salida
Terminado: Plástico



PLMX-250-1
Conector 180° para perfil de aluminio empotrado interior
Terminado: Aluminio



PLMX-250-3
Conector 90° interno para perfil de aluminio empotrado interior
Terminado: Aluminio



PLMX-250-2
Conector 90° externo para perfil de aluminio empotrado interior
Terminado: Aluminio





PERFIL LINEAL EMPOTRAR A PISO
PLMX-250-2212-AL

[Descargar Archivos](#)

Incrustar a Piso

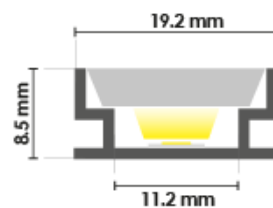
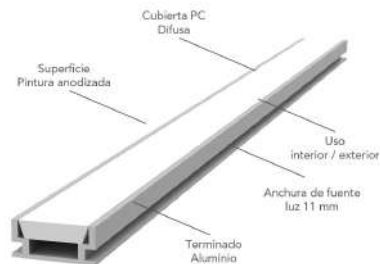

2	Aluminio Material Carcasa	20
METROS		IP

Cubierta: Policarbonato Difusa
 Dimensiones: 19.2x85 mm

INSTALACIÓN



ACCESORIOS



PLMX-250-2212-1

Tapa final para perfil de aluminio empotrado en piso sin salida
 Terminado: Plástico



PLMX-250-2212-2

Tapa final para perfil de aluminio empotrado en piso con salida
 Terminado: Plástico





PERFIL LINEAL DE PLÁSTICO PARA ESQUINAS
PLMX-250-2020E-PP

Descargar Archivos

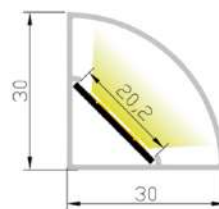

2	Plástico	20
METROS	Material Carcasa	IP

Dimensiones: 30x30 mm

INSTALACIÓN

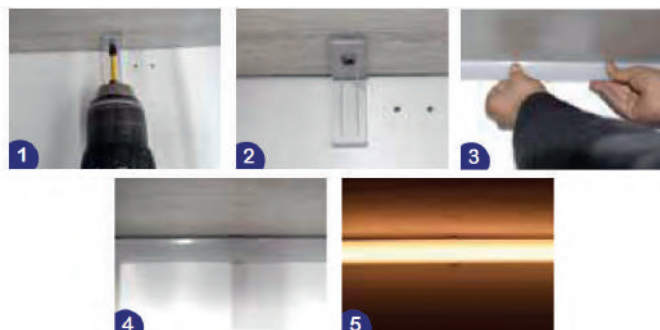
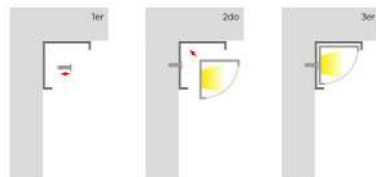

ACCESORIOS



PLMX-250-2020E-1

Tapa final para perfil de plástico para esquina sin salida

Terminado: Plástico



PLMX-250-2020E-1

Tapa final para perfil de plástico para esquina con salida

Terminado: Plástico



PLMX-250-2020E-2

Grapa de montaje para perfil de plástico para esquina

Terminado: Plástico

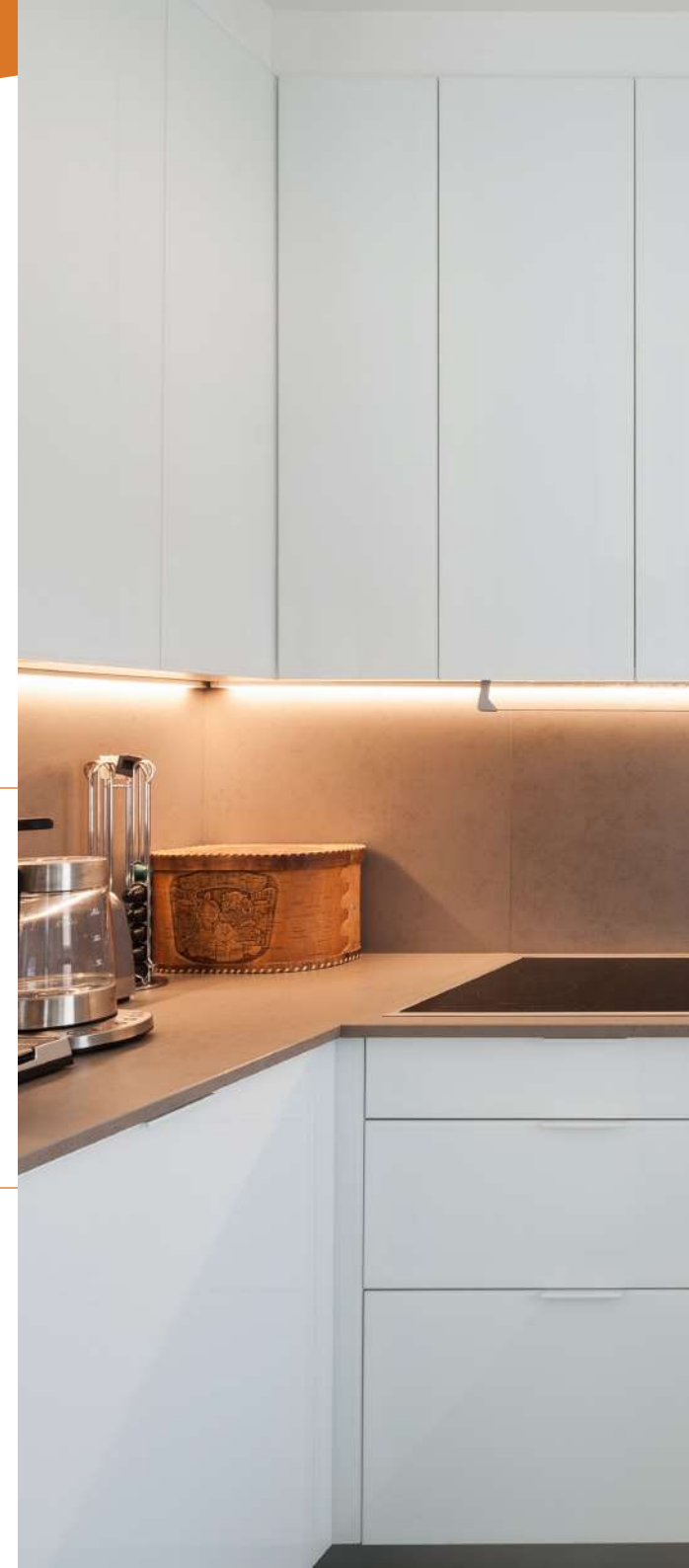





DRIVERS Y
Controladores

DRIVERS

DRIVERLED-24V-100W-PR

[Descargar Archivos](#)



24V	100-277	3.75 A	100W
Voltaje de Entrada	Voltaje de Salida	Corriente de Salida MÁX	Potencia máxima

Dimensiones: 190x50x37 mm

DRIVERLED-24V-200W-PR

[Descargar Archivos](#)



Con Switch seleccionador de voltaje

100-277	24V	7.6 A	200W
Voltaje de Entrada	Voltaje de Salida	Corriente de Salida MÁX	Potencia máxima

Dimensiones: 215x115x50 mm

CONTROLADORES

CONTROL BÁSICO PARA TIRA LED M5+M3-3A

[Descargar Archivos](#)



Controlador 12V para tiras dual o monocromáticas incluye control remoto
Control remoto radiofrecuencia: 15 m

12-24V _m	108-216	3A
V	W	en 3 Canales Salida

CONTROLADOR TUYA C-RGBW-TUYA

[Descargar Archivos](#)



Incluye control remoto
Salida: 2A por canal (máx. 10A)

12-24V _m	120-240
V	W

REPETIDOR DE ENERGÍA LED 4X5A LT-3040-5A

[Descargar Archivos](#)



Incluye Control Remoto
Para uso con
TIRAS RGB/RGBW - REFLECTORES - SUBACUÁTICOS
Aislamiento: Clase 3

5-24V _m	240-480	20
V	W	IP

ILUMINACIÓN
DE *Emergencia*

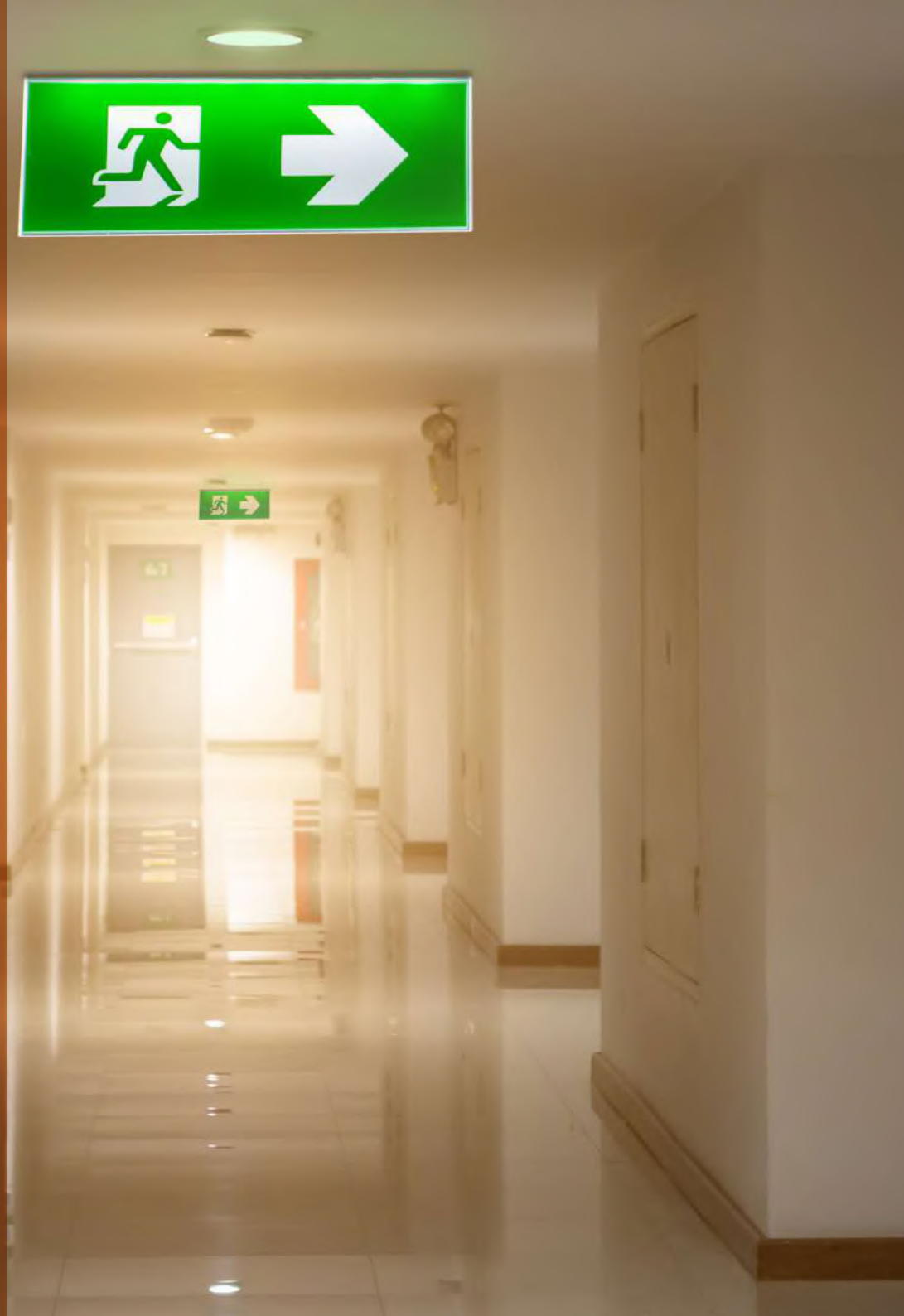

MEBSUTA I
2EMLED20MV65B

[Descargar Archivos](#)

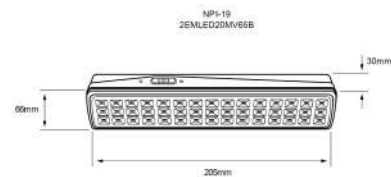

 Sobreponer Pared/Muro	Blanco	0.5 W	6500K	60 lm	100-240 Voltaje	70 IRC	 20.000h	120 Grado de Apertura	ABS Material Carcasa
---------------------------	--------	----------	-------	----------	--------------------	-----------	-------------	--------------------------	-------------------------

MEBSUTA II
4EMLED36MV65B

[Descargar Archivos](#)

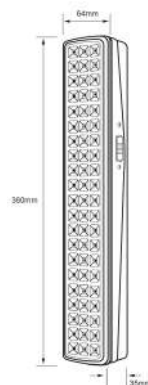

 Sobreponer Pared/Muro	Blanco	1 W	6500K	180 lm	100-240 Voltaje	70 IRC	 20.000h	120 Grado de Apertura	ABS Material Carcasa
---------------------------	--------	--------	-------	-----------	--------------------	-----------	-------------	--------------------------	-------------------------





VIGIA
4EMLED2H20MV65B
[Descargar Archivos](#)

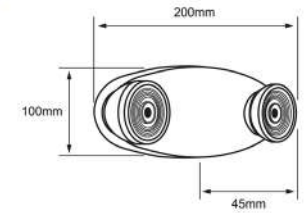

 Sobreponer Pared/Muro	Blanco	4 W	6500K	200 lm	100-277 Voltaje	80 IRC	 30.000h	60 Grado de Apertura	Policarbonato Material Carcasa
---------------------------	--------	--------	-------	-----------	--------------------	-----------	-------------	-------------------------	-----------------------------------

ADHIL
12EMPTLLED65MVB
[Descargar Archivos](#)



TIEMPO DE CARGA
6hrs

DURACIÓN DE BATERIA
3hrs

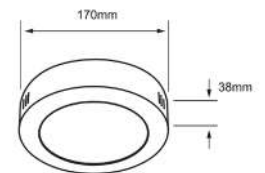

 Sobreponer Techo	Blanco	12 W	6500K	800 lm	100-240 Voltaje	80 IRC	 15.000h	100 Grado de Apertura	Aluminio Material Carcasa
----------------------	--------	---------	-------	-----------	--------------------	-----------	-------------	--------------------------	------------------------------

VIGIA
09EMA19LED30MV
09EMA19LED65MV

[Descargar Archivos](#)



TIPO
LINTERNA



TIEMPO
DE CARGA
6hrs



DURACIÓN
DE BATERIA
5hrs



9 w	3000K 6500K	670 lm	100-240 Voltaje	80 IRC	25.000h	160 Grado de Apertura	Plástico Material Carcasa
--------	----------------	-----------	--------------------	-----------	---------	-----------------------------	---------------------------------



Industrial

OPORTO VI
120EST236SLG
[Descargar Archivos](#)

IP
65

T8 X2



	Gris	100-277 Voltaje	T8 X2 No lo Incluye	Policarbonato Material Carcasa
--	-------------	--------------------	------------------------	-----------------------------------

IN4044GBNB
IN4045GBNB
CONSTRULITA
[Descargar Archivos](#)

IP
65

INTERCONEXIÓN

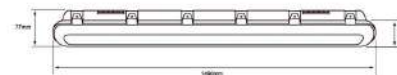

	Gris	56 W	4000K 6500K	5700 lm	100-277 Voltaje	80 IRC	30.000h	120 Grado de Apertura	ABS/PC Material Carcasa
--	-------------	---------	----------------	------------	--------------------	-----------	---------	--------------------------	----------------------------

RKU
79 3244
2G1

ic
70



2
ANDÉN

REGOR I
100UFOLED65MVN

[Descargar Archivos](#)

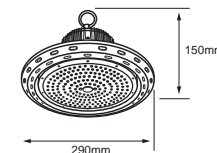

Suspend	Negro	100 W	6500K	10000 lm	100-277 Voltaje	80 IRC	30.000h	90 Grado de Apertura	Aluminio Material Carcasa
---------	-------	----------	-------	-------------	--------------------	-----------	---------	-------------------------	------------------------------

REGOR II
150UFOLED65MVN

[Descargar Archivos](#)

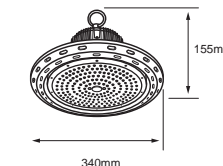

Suspend	Negro	150 W	6500K	15000 lm	100-277 Voltaje	80 IRC	30.000h	90 Grado de Apertura	Aluminio Material Carcasa
---------	-------	----------	-------	-------------	--------------------	-----------	---------	-------------------------	------------------------------

REGOR III
200UFOLED65MVN

[Descargar Archivos](#)

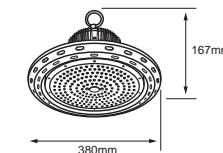

Suspend	Negro	200 W	6500K	20000 lm	100-277 Voltaje	80 IRC	30.000h	90 Grado de Apertura	Aluminio Material Carcasa
---------	-------	----------	-------	-------------	--------------------	-----------	---------	-------------------------	------------------------------

GLIESE II
60LHLED65MV120

[Descargar Archivos](#)



Incluye Campana
Incluye Adaptador E40 a E27

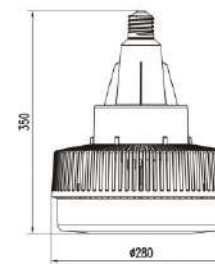

Blanco	60 W	6500K	5400 lm	100-240 Voltaje	80 IRC	20.000h	120 Grado de Apertura	Aluminio Material Carcasa
--------	---------	-------	------------	--------------------	-----------	---------	--------------------------	------------------------------

KAPPA
ES-LED/040/65

[Descargar Archivos](#)

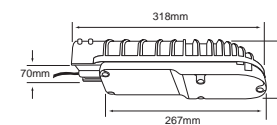

Punta de Poste	Satinado	40 W	6500K	4100 lm	100-240 Voltaje	80 IRC	30.000h	110 Grado de Apertura	Aluminio Material Carcasa
----------------	----------	---------	-------	------------	--------------------	-----------	---------	--------------------------	------------------------------





A modern house at night with a pool and garden, featuring the text "ILUMINACIÓN Exterior" overlaid. The house has large windows and a balcony. The garden includes a pool, a hedge, and various plants. The text is in white, with "ILUMINACIÓN" in a clean, sans-serif font and "Exterior" in a large, elegant script font.

ILUMINACIÓN
Exterior

APLIQUES
DE *Muro*



VERITATE II
6HLED1159MV30N
[Descargar Archivos](#)



54
IP

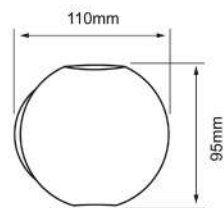

TITAWIN
09HLED923MV30N
[Descargar Archivos](#)



54
IP

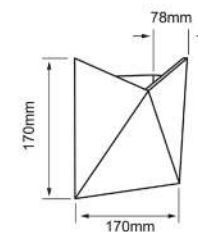

	Negro	6 W	3000K	394 lm	100-240 Voltaje	80 IRC		55 Grado de Apertura	Aluminio Material Carcasa
--	--------------	---------------	--------------	------------------	--------------------	------------------	--	--------------------------------	------------------------------

	Negro	9 W	3000K	759 lm	100-240 Voltaje	80 IRC		97 Grado de Apertura	Aluminio Material Carcasa
--	--------------	---------------	--------------	------------------	--------------------	------------------	--	--------------------------------	------------------------------

124





AUSTRALIS
09HLED1177MV30B
09HLED1177MV30G

[Descargar Archivos](#)

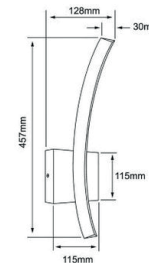

44
IP



 Sobreponer Pared/Muro	Blanco Gris	9 W	3000K	420 lm	100-240 Voltaje	80 IRC	 15.000h	111 Grado de Apertura	Aluminio Material Carcasa
---	----------------	--------	-------	-----------	--------------------	-----------	--	-----------------------------	---------------------------------

AACHEN II
8HLED1180MV30N
[Descargar Archivos](#)

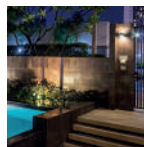

IP
65

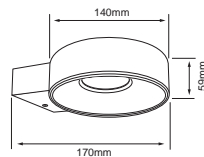

	Negro	8 W	3000K	600 lm	100-240 Voltaje	80 IRC		120 Grado de Apertura	Aluminio Material Carcasa
--	--------------	---------------	--------------	------------------	---------------------------	------------------	--	---------------------------------	-------------------------------------

AACHEN III
8HLED1181MV30N
[Descargar Archivos](#)

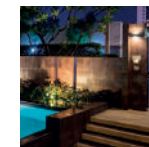

IP
65

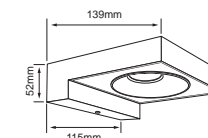

	Negro	8 W	3000K	600 lm	100-240 Voltaje	80 IRC		120 Grado de Apertura	Aluminio Material Carcasa
--	--------------	---------------	--------------	------------------	---------------------------	------------------	--	---------------------------------	-------------------------------------

AL MANAMA
HLED-370/N
[Descargar Archivos](#)



45
IP

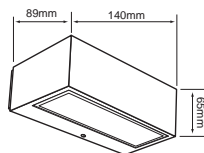

	Negro	8 W	4000K	450 lm	100-240 Voltaje	80 IRC		30 Grado de Apertura	Aluminio Material Carcasa
--	--------------	---------------	--------------	------------------	---------------------------	------------------	--	--------------------------------	-------------------------------------

AL MANAMA I
HLED-371/N
[Descargar Archivos](#)



45
IP

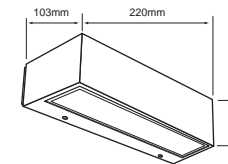

	Negro	20 W	4000K	1200 lm	100-240 Voltaje	80 IRC		30 Grado de Apertura	Aluminio Material Carcasa
--	--------------	----------------	--------------	-------------------	---------------------------	------------------	--	--------------------------------	-------------------------------------

PLEYONE
10HLED407VG

[Descargar Archivos](#)



44
IP

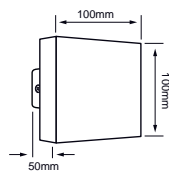

	Gris	9.5 W	3000K	500 lm	100-127 Voltaje	80 IRC	20.000h	22 Grado de Apertura	Aluminio Material Carcasa
--	------	----------	-------	-----------	--------------------	-----------	---------	-------------------------	------------------------------

TAIGETE
HLED-408/G

[Descargar Archivos](#)



44
IP

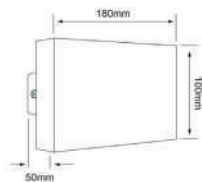

	Gris	17 W	3000K	700 lm	100-127 Voltaje	80 IRC	20.000h	19 Grado de Apertura	Aluminio Material Carcasa
--	------	---------	-------	-----------	--------------------	-----------	---------	-------------------------	------------------------------

TAIGETE II
14HLED409MV30G

[Descargar Archivos](#)



44
IP

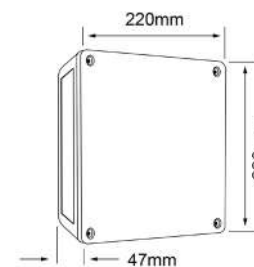

	Gris	14.5 W	3000K	580 lm	100-240 Voltaje	80 IRC	20.000h	55 Grado de Apertura	Polícarbonato Material Carcasa
--	------	-----------	-------	-----------	--------------------	-----------	---------	-------------------------	-----------------------------------





ZIGONG
HLED-402/7.5W/30/B

[Descargar Archivos](#)



45
IP



	Blanco	7.5 W	3000K	150 lm	100-240 Voltaje	80 IRC	20.000h	160 Grado de Apertura	Aluminio Material Carcasa
--	--------	----------	-------	-----------	--------------------	-----------	---------	--------------------------	------------------------------

RAVENNE
HLED-840

[Descargar Archivos](#)



55
IP

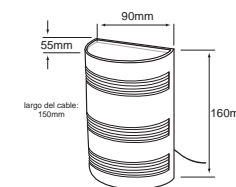

	Negro	6 W	4000K	300 lm	100-240 Voltaje	80 IRC	15.000h	70 Grado de Apertura	Aluminio Material Carcasa
--	-------	--------	-------	-----------	--------------------	-----------	---------	-------------------------	------------------------------

ZIBO
HLED-401/7.5W/30/B

[Descargar Archivos](#)

Ángulo de Apertura
Ajustable

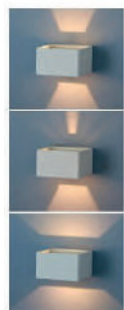

44
IP

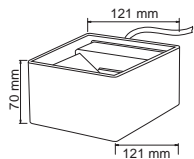

	Blanco	7.5 W	3000K	250 lm	100-240 Voltaje	80 IRC	20.000h	155 Grado de Apertura	Aluminio Material Carcasa
--	--------	----------	-------	-----------	--------------------	-----------	---------	--------------------------	------------------------------

RAWENNA
HLED-841

[Descargar Archivos](#)

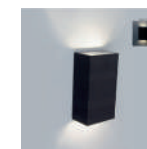

55
IP

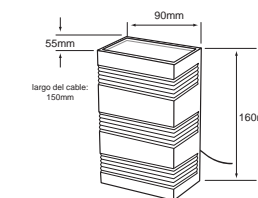

	Negro	6 W	4000K	300 lm	100-240 Voltaje	80 IRC	15.000h	70 Grado de Apertura	Aluminio Material Carcasa
--	-------	--------	-------	-----------	--------------------	-----------	---------	-------------------------	------------------------------

PROCYON
HLED-1178/30/G

Descargar Archivos

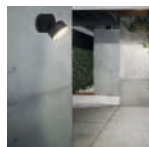

44
IP

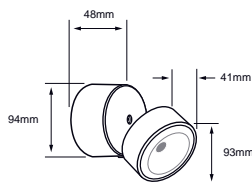

	Gris	10 W	3000K	800 lm	127 Voltaje	80 IRC		107 Grado de Apertura	Aluminio Material Carcasa
--	------	---------	-------	-----------	----------------	-----------	--	--------------------------	------------------------------

ADHARA I
HLED-1174/30/G

Descargar Archivos



IP
65

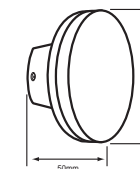

	Gris	10 W	3000K	700 lm	100-240 Voltaje	80 IRC		106 Grado de Apertura	Aluminio Material Carcasa
--	------	---------	-------	-----------	--------------------	-----------	--	--------------------------	------------------------------

EDULIS
HLED-844/30/CR

Descargar Archivos



54
IP

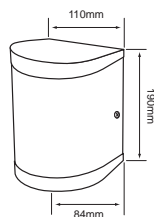

	Cromo	14.5 W	3000K	900 lm	100-240 Voltaje	80 IRC		180 Grado de Apertura	Aluminio Material Carcasa
--	-------	-----------	-------	-----------	--------------------	-----------	--	--------------------------	------------------------------

ENCKE
HLED-1105/S

Descargar Archivos

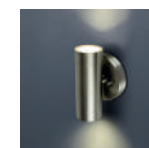

44
IP

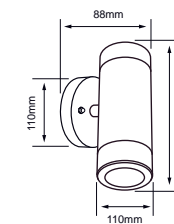

	Satín	9 W	3000K	600 lm	127 Voltaje	80 IRC		49 Grado de Apertura	Aluminio Material Carcasa
--	-------	--------	-------	-----------	----------------	-----------	--	-------------------------	------------------------------





KAUS II
24HLED414V30S

[Descargar Archivos](#)

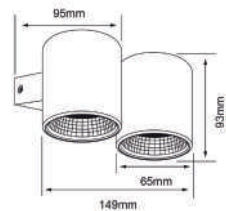
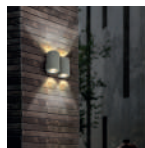

	Satinado	24 W	3000K	1441 lm	100-127 Voltaje	80 IRC	15.000h	205 Grado de Apertura	Aluminio Material Carcasa
--	----------	---------	-------	------------	--------------------	-----------	---------	--------------------------	------------------------------

KAUS I
28HLED413V30S

[Descargar Archivos](#)

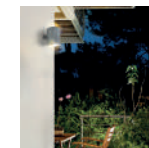

	Satinado	28 W	3000K	2185 lm	100-240 Voltaje	80 IRC	15.000h	282 Grado de Apertura	Aluminio Material Carcasa
--	----------	---------	-------	------------	--------------------	-----------	---------	--------------------------	------------------------------

HYADUM
HLED-847/30/G

[Descargar Archivos](#)



44
IP

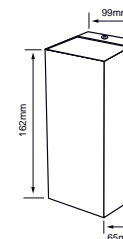

	Gris	9 W	3000K	420 lm	100-127 Voltaje	80 IRC	20.000h	41 Grado de Apertura	Aluminio Material Carcasa
--	------	--------	-------	-----------	--------------------	-----------	---------	-------------------------	------------------------------



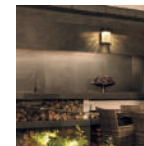

CRUX
HLED-201/N

[Descargar Archivos](#)



44
IP



 Sobreponer Pared/Muro	Negro	16 W	3000K	800 lm	100-240 Voltaje	80 IRC	 20.000h	120 Grado de Apertura	Aluminio Material Carcasa
---	--------------	---------	-------	-----------	--------------------	-----------	---	--------------------------	------------------------------

TUTTLE
HLED-202/30/N

[Descargar Archivos](#)

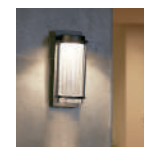

44
IP

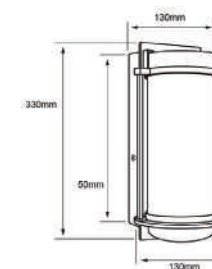

 Sobreponer Pared/Muro	Negro	16 W	3000K	730 lm	127 Voltaje	80 IRC	 20.000h	120 Grado de Apertura	Aluminio Material Carcasa
---	--------------	---------	-------	-----------	----------------	-----------	---	--------------------------	------------------------------

COPEINA
HLED-1051/30/G

[Descargar Archivos](#)



IP
65

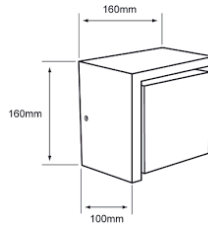

Gris

15
W

3000K

900
lm

100-240
Voltaje

80
IRC

20.000h

130
Grado de Apertura

Aluminio
Material Carcasa

COPEINA I
HLED-1052/30/G

[Descargar Archivos](#)



IP
65

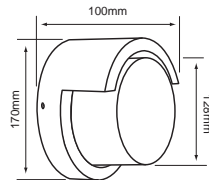
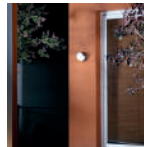

Gris

15
W

3000K

900
lm

100-240
Voltaje

80
IRC

20.000h

130
Grado de Apertura

Aluminio
Material Carcasa





WEZEN
10HLED947V30G

[Descargar Archivos](#)

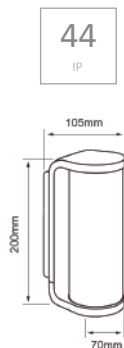
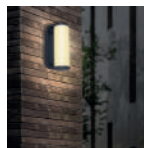

	Gris	10 W	3000K	600 lm	127 Voltaje	80 IRC	20.000h	118 Grado de Apertura	Aluminio Material Carcasa
--	------	------	-------	--------	-------------	--------	---------	-----------------------	---------------------------

KYBOX
HLED-1201/G

[Descargar Archivos](#)

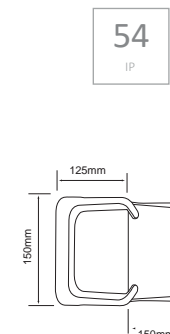

	Gris	10 W	3000K	560 lm	100-240 Voltaje	80 IRC	20.000h	155 Grado de Apertura	Aluminio Material Carcasa
--	------	------	-------	--------	-----------------	--------	---------	-----------------------	---------------------------

FURUD
27HLED1162V30G

[Descargar Archivos](#)

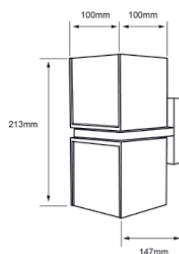

	Gris	27 W	3000K	1100 lm	127 Voltaje	80 IRC	20.000h	110 Grado de Apertura	Aluminio Material Carcasa
--	------	------	-------	---------	-------------	--------	---------	-----------------------	---------------------------

PERSEIDA
HLED-1152/G

[Descargar Archivos](#)

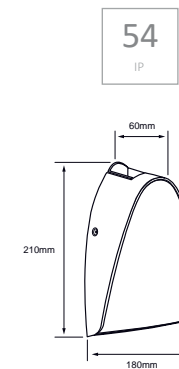
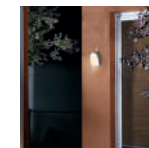

	Gris	16 W	3000K	600 lm	127 Voltaje	80 IRC	20.000h	150 Grado de Apertura	Aluminio Material Carcasa
--	------	------	-------	--------	-------------	--------	---------	-----------------------	---------------------------



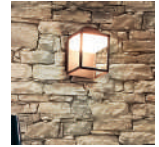

OXALIS
FTL-LED/008/30/N

[Descargar Archivos](#)

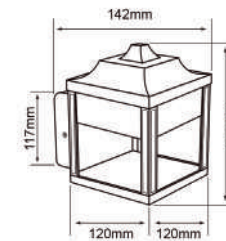

44
IP



 Sobreponer Pared/Muro	Negro	9 W	3000K	330 lm	100-127 Voltaje	80 IRC	 20.000h	87 Grado de Apertura	Aluminio Material Carcasa
---	--------------	---------------	--------------	------------------	--------------------	------------------	---	-----------------------------------	--

SIRIO
20FTL3424MVN

⬇ Descargar Archivos

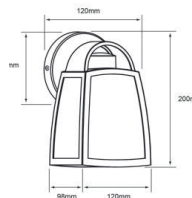

 Sobreponer Pared/Muro	Negro	 No lo Incluye	Aluminio Material Carcasa	44 IP
--	--------------	--	-------------------------------------	-----------------

SPICA
FTL-3423/BA

⬇ Descargar Archivos

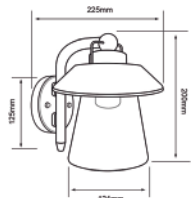
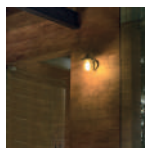

 Sobreponer Pared/Muro	Bronce	 No lo Incluye	Aluminio Material Carcasa	44 IP
---	---------------	---	-------------------------------------	-----------------

POZNA
FTL-3420/S

⬇ Descargar Archivos

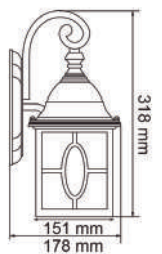
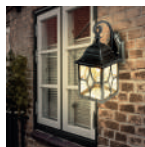

 Sobreponer Pared/Muro	Satinado	 No lo Incluye	Aluminio Material Carcasa	44 IP
--	-----------------	--	-------------------------------------	-----------------



140



SALERMO
FTL-6002/N

Descargar Archivos

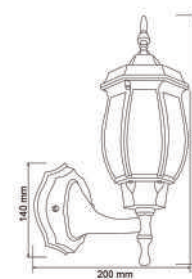

Negro



No lo Incluye

Aluminio
Material
Carcasa

44
IP

RONDA I
FTL-3801/BA

[Descargar Archivos](#)



Bronce Antiguo



Aluminio
Material Carcasa

44
IP

SANTIAGO
FTL-6003/N

[Descargar Archivos](#)



Bronce Antiguo



Aluminio
Material Carcasa

44
IP





TOLEDO
H-1070/AN
H-1070/S

[Descargar Archivos](#)

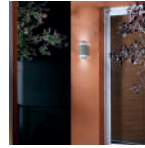

45

IP

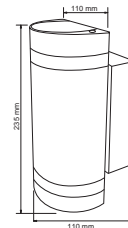

	Antracita		Aluminio
Sobreponer Pared/Muro	Satinado	No lo Incluye	Material Carcasa

RAUCH
H-1151/AN

[Descargar Archivos](#)



44

IP

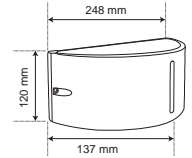

	Antracita		Aluminio
Sobreponer Pared/Muro		No lo Incluye	Material Carcasa

URBINO
H-945/B
H-945/S

[Descargar Archivos](#)

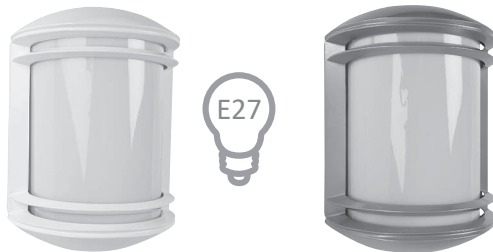

44

IP

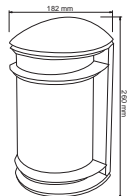

	Blanco		Aluminio
Sobreponer Pared/Muro	Satinado	No lo Incluye	Material Carcasa

TOULON III
20H1175MVS

[Descargar Archivos](#)



44

IP

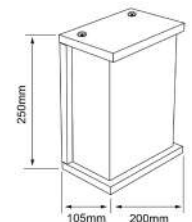

	Satinado		Aluminio
Sobreponer Pared/Muro		No lo Incluye	Material Carcasa



KAVE IV
5HLED812CV30G
5HLED812CV30N
[Descargar Archivos](#)

44
IP

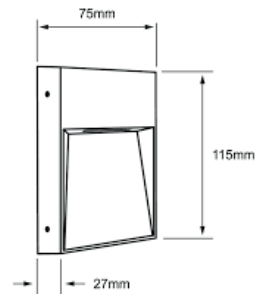
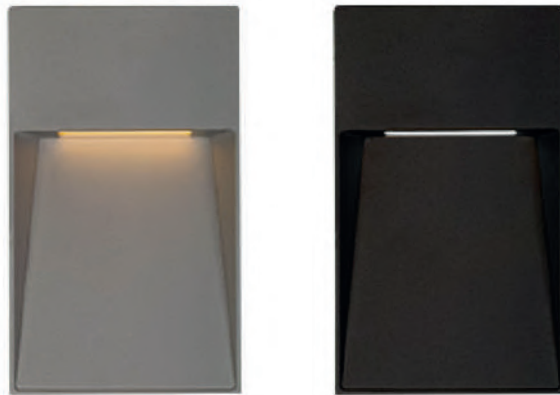

KAVE V
24HLED813CV30G
24HLED813CV30N
[Descargar Archivos](#)

44
IP

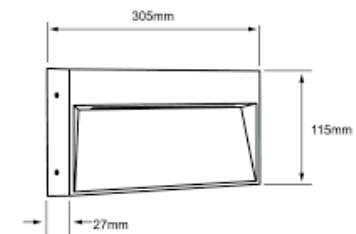

145

	Gris Negro	5 W	3000K	200lm 150lm	127 Voltaje	80 IRC	15.000h	45 Grado de Apertura	Aluminio Material Carcasa
--	---------------	--------	-------	----------------	----------------	-----------	---------	-------------------------	------------------------------

	Gris Negro	24 W	3000K	1030lm 760lm	127 Voltaje	80 IRC	15.000h	51 Grado de Apertura	Aluminio Material Carcasa
--	---------------	---------	-------	-----------------	----------------	-----------	---------	-------------------------	------------------------------

KAVE II
16HLED808CV30G
16HLED808CV30N

[Descargar Archivos](#)

54

IP

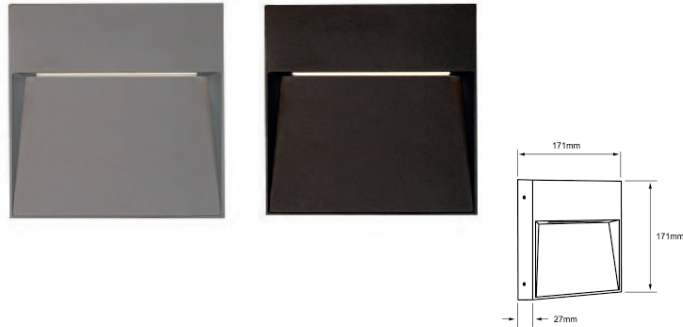

	Gris	16	3000K	710lm	127	80	15.000h	51	Aluminio
Sobreponer Pared/Muro	Negro	W		550lm	Voltaje	IRC		Grado de Apertura	Material Carcasa

KAVE III
24HLED809CV30G
24HLED809CV30N

[Descargar Archivos](#)

54

IP

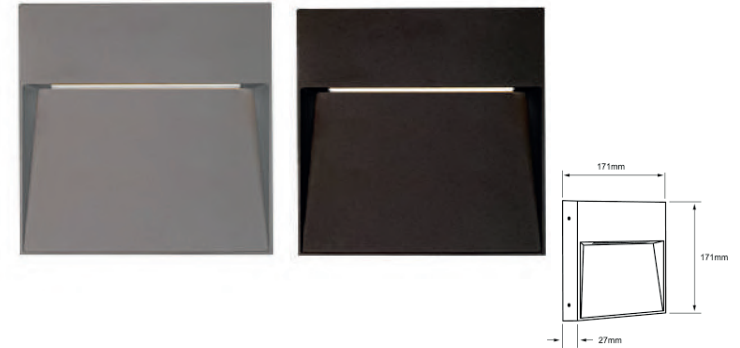

	Gris	24	3000K	1050lm	127	80	15.000h	52	Aluminio
Sobreponer Pared/Muro	Negro	W		800lm	Voltaje	IRC		Grado de Apertura	Material Carcasa

HUNOR II
16HLED808RV30G
16HLED808RV30N

[Descargar Archivos](#)

54

IP

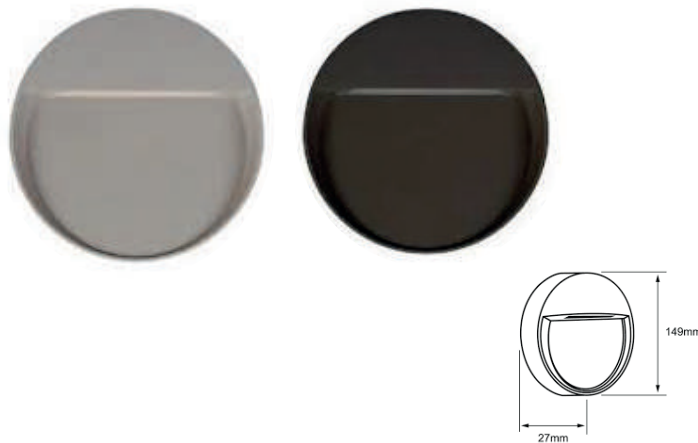

	Gris	16	3000K	700lm	127	80	15.000h	48	Aluminio
Sobreponer Pared/Muro	Negro	W		550lm	Voltaje	IRC		Grado de Apertura	Material Carcasa

HUNOR III
24HLED809RV30G
24HLED809RV30N

[Descargar Archivos](#)

54

IP

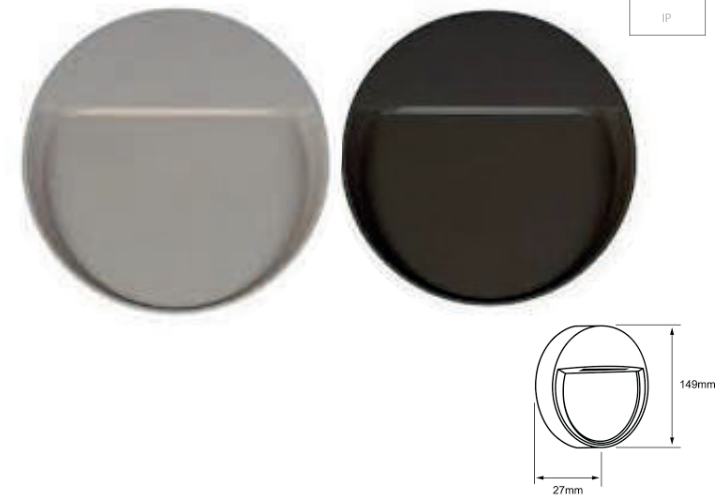

	Gris	24	3000K	960lm	127	80	15.000h	47	Aluminio
Sobreponer Pared/Muro	Negro	W		720lm	Voltaje	IRC		Grado de Apertura	Material Carcasa



ANSHAN IV
HLED-805/S

[Descargar Archivos](#)



Ideal para
Zonas Costeras

IP
65

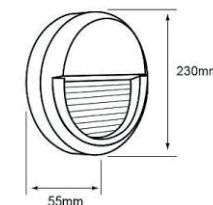
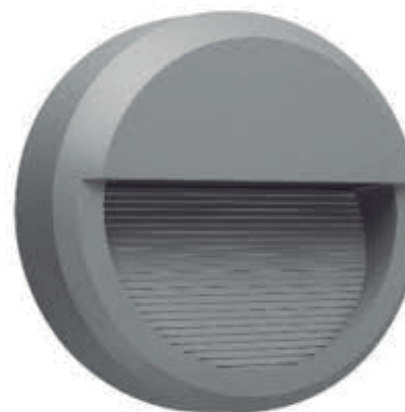

Satinado

9.5
W

3000K

250
lm

100-240
Voltaje

80
IRC

15.000h

47
Grado de Apertura

Plástico
Material Carcasa

ANSHAN V
HLED-806/S

[Descargar Archivos](#)



Ideal para
Zonas Costeras

IP
65

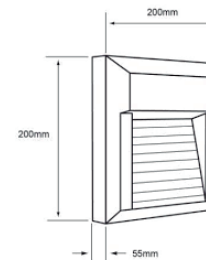

Satinado

9.5
W

3000K

250
lm

100-240
Voltaje

80
IRC

20.000h

47
Grado de Apertura

Plástico
Material Carcasa

ANSHAN II
HLED-804/B
HLED-804/G

Descargar Archivos

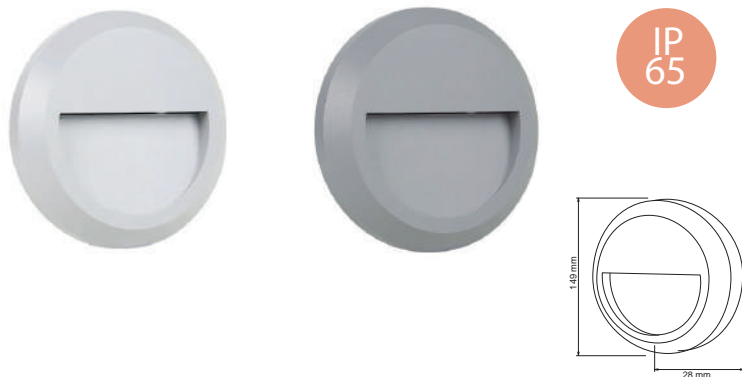

IP
65

Sobreponer Pared/Muro	Blanco	1 W	4000K	100 lm	100-127 Voltaje	80 IRC	15.000h	Material Carcasa
	Gris							

ANSHAN I
HLED-803/B
HLED-803/G

Descargar Archivos



IP
65

Sobreponer Pared/Muro	Blanco	1 W	4000K	100 lm	100-127 Voltaje	80 IRC	15.000h	Material Carcasa
	Gris							

ANSHAN
HLED-801/B
HLED-801/G

Descargar Archivos



IP
65

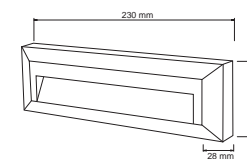

Sobreponer Pared/Muro	Blanco	1.5 W	4000K	120 lm	100-127 Voltaje	80 IRC	15.000h	Material Carcasa
	Gris							

CERDEÑA
HLED-905/S

Descargar Archivos

IP
65

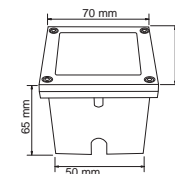

Incluir Pared/Muro	Satinado	0.6 W	3000K	4 lm	100-127 Voltaje	80 IRC	15.000h	120 Grado de Apertura	Lámina de Acero Material Carcasa
--------------------	----------	----------	-------	---------	--------------------	-----------	---------	--------------------------	-------------------------------------

CERDEÑA I
HLED-910/S

Descargar Archivos

IP
65

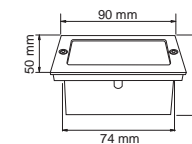

Incluir Pared/Muro	Satinado	0.6 W	3000K	4 lm	100-127 Voltaje	80 IRC	15.000h	120 Grado de Apertura	Lámina de Acero Material Carcasa
--------------------	----------	----------	-------	---------	--------------------	-----------	---------	--------------------------	-------------------------------------

BHARANI
HLED-907/30/G

Descargar Archivos



54

IP

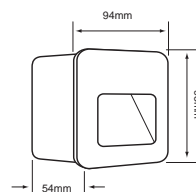

	Gris	2 W	3000K	50 lm	100-127 Voltaje	80 IRC	20.000h	29 Grado de Apertura	Aluminio Material Carcasa
--	------	-----	-------	-------	-----------------	--------	---------	----------------------	---------------------------

CETI
HLED-916/30/G

Descargar Archivos



54

IP

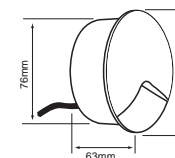

	Gris	2.5 W	3000K	35 lm	100-127 Voltaje	80 IRC	20.000h	29 Grado de Apertura	Aluminio Material Carcasa
--	------	-------	-------	-------	-----------------	--------	---------	----------------------	---------------------------

AVIOR
HLED-903/B

Descargar Archivos



IP
65

	Blanco	1.5 W	3000K	60 lm	100-240 Voltaje	80 IRC	15.000h	50 Grado de Apertura	Plastico Material Carcasa
--	--------	-------	-------	-------	-----------------	--------	---------	----------------------	---------------------------

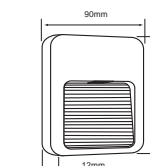

Reflectores



LUMIERE I
LQ-LED/001/30
LQ-LED/001/65

[Descargar Archivos](#)

IP
65

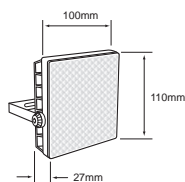



 Piso	Negro	10 W	3000K 6500K	800 lm	100-240 Voltaje	80 IRC	 25.000h	90 Grado de Apertura	Aluminio Material Carcasa
---	--------------	---------	----------------	-----------	--------------------	-----------	--	-------------------------	------------------------------

LUMIERE II
LQ-LED/002/30
LQ-LED/002/65

[Descargar Archivos](#)

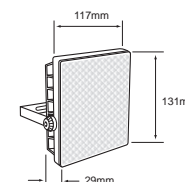
IP
65



 Piso	Negro	20 W	3000K 6500K	1600 lm	100-240 Voltaje	80 IRC	 25.000h	90 Grado de Apertura	Aluminio Material Carcasa
---	--------------	---------	----------------	------------	--------------------	-----------	--	-------------------------	------------------------------

LUMIERE III
LQ-LED/003/30
LQ-LED/003/65

[Descargar Archivos](#)

IP
65

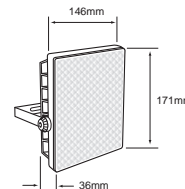



 Piso	Negro	30 W	3000K 6500K	2400 lm	100-240 Voltaje	80 IRC	 25.000h	90 Grado de Apertura	Aluminio Material Carcasa
---	--------------	---------	----------------	------------	--------------------	-----------	--	-------------------------	------------------------------

LUMIERE IV
LQ-LED/004/30
LQ-LED/004/65

[Descargar Archivos](#)

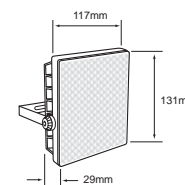
IP
65



 Piso	Negro	50 W	3000K 6500K	4000 lm	100-240 Voltaje	80 IRC	 25.000h	90 Grado de Apertura	Aluminio Material Carcasa
---	--------------	---------	----------------	------------	--------------------	-----------	--	-------------------------	------------------------------





ZIBAL I
10LQLEDT30MVN
10LQLEDT65MVN

Descargar Archivos

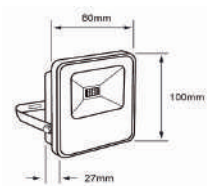

IP
65



 Piso	Negro	10 W	3000K 6500K	800 lm	100-240 Voltaje	80 IRC	 25.000h	120 Grado de Apertura	Aluminio Material Carcasa
---	--------------	----------------	-----------------------	------------------	--------------------	------------------	---	---------------------------------	------------------------------



ZIBAL II
20LQLEDT30MVN
20LQLEDT65MVN

Descargar Archivos

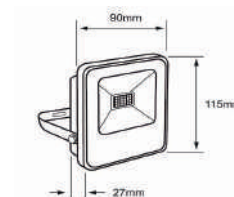

IP
65



 Piso	Negro	20 W	3000K 6500K	1600 lm	100-240 Voltaje	80 IRC	 25.000h	120 Grado de Apertura	Aluminio Material Carcasa
---	--------------	----------------	-----------------------	-------------------	--------------------	------------------	---	---------------------------------	------------------------------

ZIBAL III
30LQLEDT30MVN
30LQLEDT65MVN

Descargar Archivos



IP
65

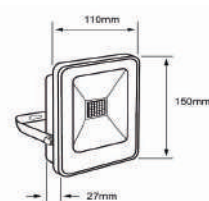

 Piso	Negro	30 W	3000K 6500K	2700 lm	100-240 Voltaje	80 IRC	 25.000h	120 Grado de Apertura	Aluminio Material Carcasa
---	--------------	----------------	-----------------------	-------------------	--------------------	------------------	---	---------------------------------	------------------------------



ZIBAL IV
50LQLEDT30MVN
50LQLEDT65MVN

Descargar Archivos

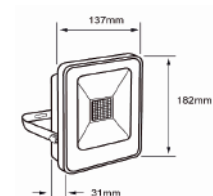

IP
65



 Piso	Negro	50 W	3000K 6500K	4500 lm	100-240 Voltaje	80 IRC	 25.000h	120 Grado de Apertura	Aluminio Material Carcasa
---	--------------	----------------	-----------------------	-------------------	--------------------	------------------	---	---------------------------------	------------------------------



LYNX
10HLED762MV30N

[Descargar Archivos](#)



IP
65

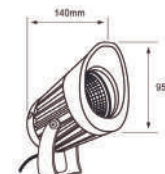

	Negro	10 W	3000K	713 lm	100-240 Voltaje	80 IRC	30.000h	27 Grado de Apertura	Aluminio Material Carcasa
--	-------	---------	-------	-----------	--------------------	-----------	---------	-------------------------	------------------------------

LYNX II
20HLED763MV30N

[Descargar Archivos](#)



IP
65

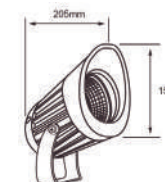

	Negro	20 W	3000K	1740 lm	100-240 Voltaje	80 IRC	30.000h	23 Grado de Apertura	Aluminio Material Carcasa
--	-------	---------	-------	------------	--------------------	-----------	---------	-------------------------	------------------------------

LYNX III
30HLED764MV30N

[Descargar Archivos](#)



IP
65

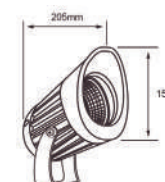

	Negro	30 W	3000K	1899 lm	100-240 Voltaje	80 IRC	30.000h	24 Grado de Apertura	Aluminio Material Carcasa
--	-------	---------	-------	------------	--------------------	-----------	---------	-------------------------	------------------------------

DENIA
H-505/N
Descargar Archivos



IP
67

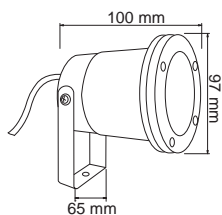

Negro



No lo Incluye

Fibra
de Vidrio
Material
Carcasa



ARCTURUS
6HLED757V30G

[Descargar Archivos](#)

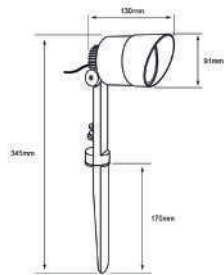

54

IP



158



 Estaca	Gris	6 W	3000K	389 lm	127 Voltaje	80 IRC	 20.000h	96 Grado de Apertura	Aluminio Material Carcasa
---	------	--------	-------	-----------	----------------	-----------	--	-------------------------	------------------------------

LIESMA
09HLED752MV30N
[Descargar Archivos](#)



IP
65

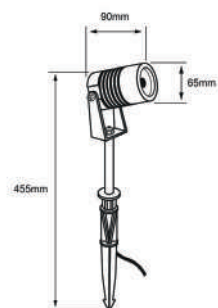

	Negro	9 W	3000K	775 lm	100-240 Voltaje	80 IRC	 30.000h	28 Grado de Apertura	Aluminio Material Carcasa
--	--------------	---------------	--------------	------------------	--------------------	------------------	--------------------	--------------------------------	------------------------------

BENDIN
HLED-776/6W/30
[Descargar Archivos](#)



IP
65

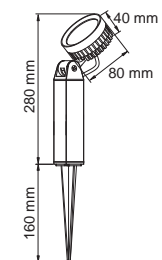











	Gris	6 W	3000K	350 lm	100-240 Voltaje	80 IRC	 20.000h	25 Grado de Apertura	Aluminio Material Carcasa
--	-------------	---------------	--------------	------------------	--------------------	------------------	--------------------	--------------------------------	------------------------------



KRAZ
12HLED751MV30N
[Descargar Archivos](#)

IP
65



 Estaca	 Negro Oro	 12 W	 3000K	 760 lm	 100-240 Voltaje	 80 IRC	 30.000h	 24 Grado de Apertura	 Aluminio Material Carcasa
--	---	--	---	--	---	--	---	--	---

BILAR H-715/N

Descargar Archivos



Ideal para
Zonas Costeras

IP
65

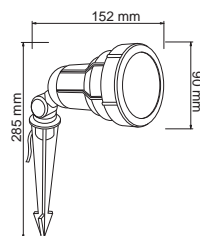

Negro



Fibra
de Vidrio
Material
Carcasa

BILAR II H-725/N

Descargar Archivos



Ideal para
Zonas Costeras

IP
65

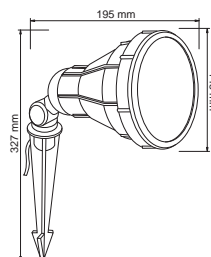

Negro



Fibra
de Vidrio
Material
Carcasa



BALAS
DE *Piso*



ESFERIS
HLED-941/30/B
6HLED941MV30N

Descargar Archivos

Descargar Archivos

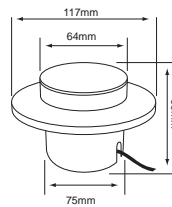

	Blanco Negro	6 W	3000K	120 lm	100-240 Voltaje	80 IRC	15.000h	152 Grado de Apertura	Aluminio Material Carcasa
--	-----------------	--------	-------	-----------	--------------------	-----------	---------	--------------------------	------------------------------

CERES
HLED-940/1W/30/S

Descargar Archivos

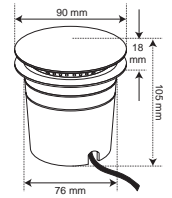

	Gris	1 W	3000K	58 lm	100-127 Voltaje	80 IRC	50.000h	360 Grado de Apertura	Aluminio Material Carcasa
--	------	--------	-------	----------	--------------------	-----------	---------	--------------------------	------------------------------

ORBIX
HLED-651/30

Descargar Archivos

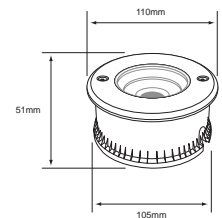

	Satinado	10 W	3000K	800 lm	100-127 Voltaje	80 IRC	20.000h	79 Grado de Apertura	Aluminio Material Carcasa
--	----------	---------	-------	-----------	--------------------	-----------	---------	-------------------------	------------------------------



BARATI
HLED-645/2W/S

Descargar Archivos

IP
65



Mini Bala

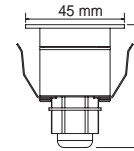

 Incrustar Piso	Satinado	2 W	3000K	60 lm	100-240 Voltaje	80 IRC	 20.000h	20 Grado de Apertura	Lámina de Acero Material Carcasa
-----------------------	----------	--------	-------	----------	--------------------	-----------	-------------	----------------------------	---

ADANA
HLED-640/5W/S

Descargar Archivos



IP
65

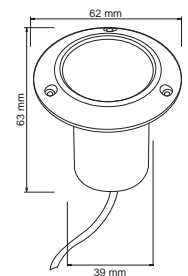

 Incrustar Piso	Satinado	5 W	3000K	150 lm	100-240 Voltaje	80 IRC	 25.000h	45 Grado de Apertura	Lámina de Acero Material Carcasa
-----------------------	----------	--------	-------	-----------	--------------------	-----------	-------------	----------------------------	---

CONSTANZA
H-605/N

Descargar Archivos



IP
65

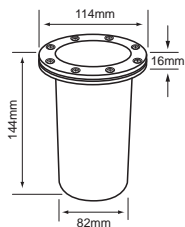

	Negro		Fibra de Vidrio Material Carcasa
Incrustar Piso		No lo incluye	

CUENCA I
H-625/N

Descargar Archivos



IP
65

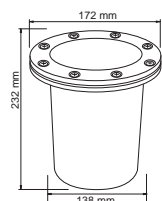

	Negro		Fibra de Vidrio Material Carcasa
Incrustar Piso		No lo incluye	

COIMBRA
H-600/S

Descargar Archivos

IP
65

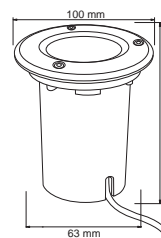

	Satinado		Lámina de Acero Material Carcasa
Incrustar Piso		No lo incluye	



A modern indoor swimming pool area. The pool is illuminated with bright blue lights, creating a shimmering effect on the water. The pool deck is made of light-colored tiles. In the background, there are several lounge chairs and a table, suggesting a relaxation area. The walls are decorated with intricate, circular patterns, and there are large columns with a mosaic-like texture. The overall atmosphere is clean, modern, and inviting.

Summergibles

ANTARES I
6HLED511DC30S

[Descargar Archivos](#)



Profundidad Max
1.5 metros

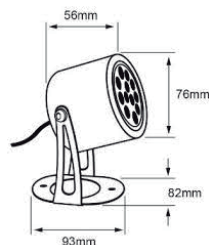

Piso	Satinado	6.5 W	3000K	450 lm	12 VDC	80 IRC	20.000h	15 Grado de Apertura	Lámina de Acero Material Carcasa
------	----------	----------	-------	-----------	-----------	-----------	---------	-------------------------	-------------------------------------

ANTARES II
10HLED512DC30S

[Descargar Archivos](#)

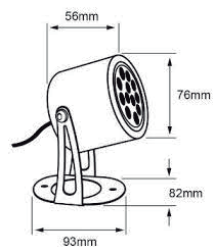

Piso	Satinado	10 W	3000K	740 lm	12 VDC	80 IRC	20.000h	21 Grado de Apertura	Lámina de Acero Material Carcasa
------	----------	---------	-------	-----------	-----------	-----------	---------	-------------------------	-------------------------------------

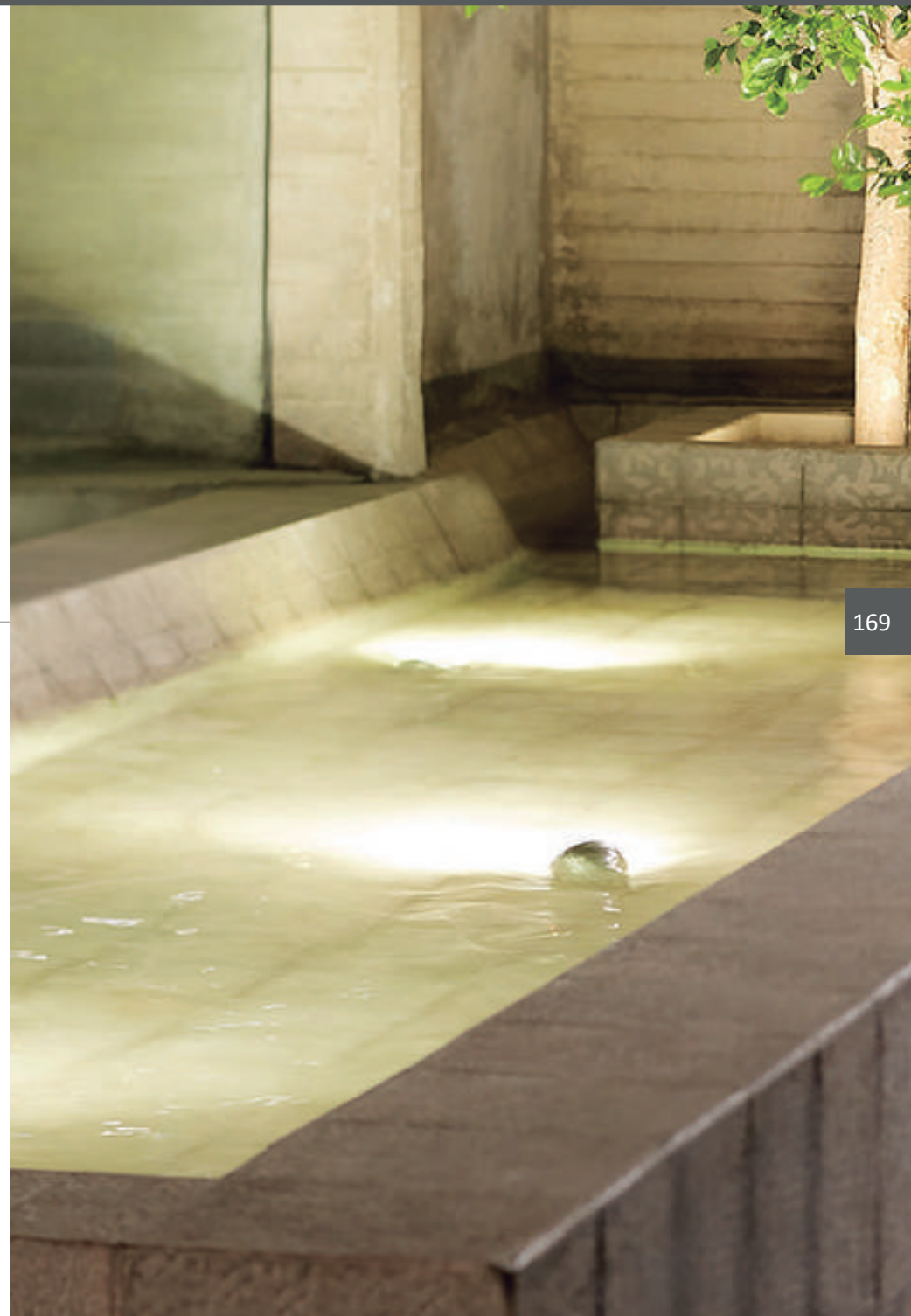

DIJON
H-520/3W/30

📄 Descargar Archivos

IP
68



Profundidad Max
1 metro

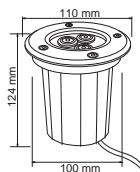

170

Se sugiere Controlador H-520/36W/CONTROL

	Satinado	3 W	3000K	150 lm	12 VDC	80 IRC		20 Grado de Apertura	Lámina de Acero Material Carcasa
--	-----------------	---------------	--------------	------------------	------------------	------------------	--	--------------------------------	-------------------------------------

DIJON
H-520/3W/RGB

📄 Descargar Archivos

IP
68



Profundidad Max
1 metro

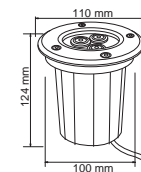

Requiere Controlador H-520/36W/CONTROL

	Satinado	3 W		150 lm	12 VDC	80 IRC		20 Grado de Apertura	Lámina de Acero Material Carcasa
--	-----------------	---------------	--	------------------	------------------	------------------	--	--------------------------------	-------------------------------------

H-520/36W/CONTROL

📄 Descargar Archivos



Secuencia de 7 colores y cambio de color cada 12 y 40 segs.
Soporta hasta 6 luminarios interconectados en 25 mts. máx.
Incluye control remoto.

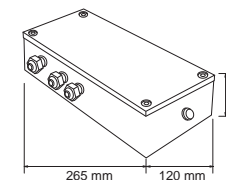



MINI

Postes

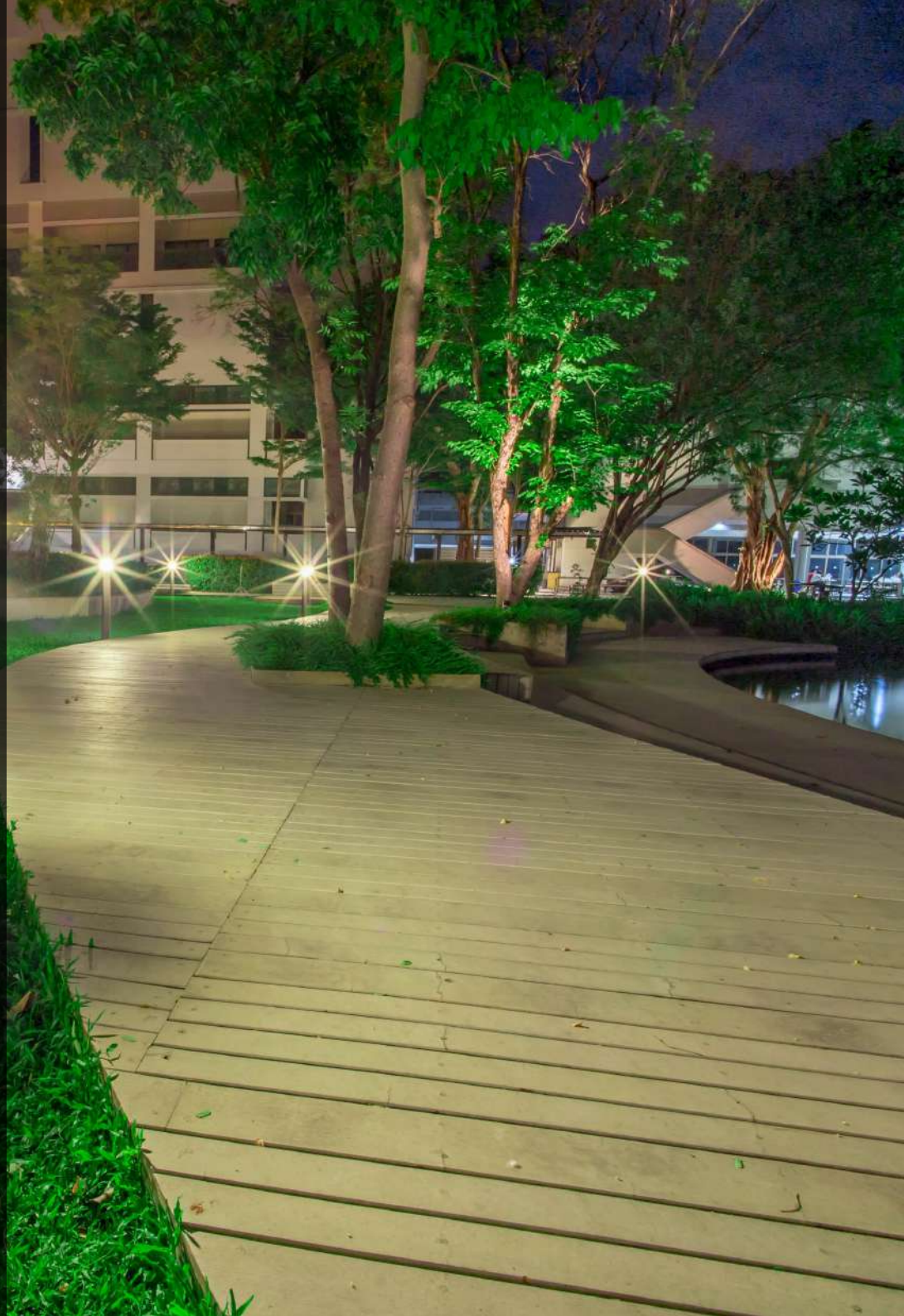

COMA
09HLED429MV30N

[Descargar Archivos](#)



54
IP



	Negro	9 W	3000K	507 lm	100-240 VDC	80 IRC	30.000h	38 Grado de Apertura	Aluminio Material Carcasa
--	--------------	--------	-------	-----------	----------------	-----------	---------	-------------------------	------------------------------

EQUULEUS
09HLED431MV30N

[Descargar Archivos](#)



54
IP

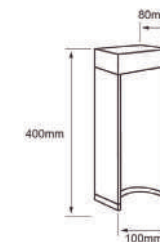

	Negro	9 W	3000K	349 lm	100-240 VDC	80 IRC	30.000h	102 Grado de Apertura	Aluminio Material Carcasa
--	--------------	--------	-------	-----------	----------------	-----------	---------	--------------------------	------------------------------

DRACO
09HLED1203MV30N

[Descargar Archivos](#)



54
IP

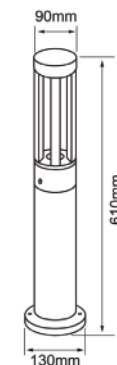



	Negro	9 W	3000K	418 lm	100-240 VDC	80 IRC	30.000h	115 Grado de Apertura	Aluminio Material Carcasa
--	--------------	--------	-------	-----------	----------------	-----------	---------	--------------------------	------------------------------

OBELIX III
HLED-003/N/30

[Descargar Archivos](#)



 Piso	Negro	13 W	3000K	770 lm	100-240 VDC	80 IRC	 30.000h	120 Grado de Apertura	Aluminio Material Carcasa
---	--------------	----------------	--------------	------------------	----------------	------------------	---	---------------------------------	------------------------------

174

OBELIX IV
HLED-004/N/30

[Descargar Archivos](#)

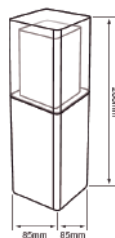



 Piso	Negro	13 W	3000K	810 lm	100-240 VDC	80 IRC	 30.000h	120 Grado de Apertura	Aluminio Material Carcasa
---	--------------	----------------	--------------	------------------	----------------	------------------	---	---------------------------------	------------------------------

ADHARA II
HLED-1175/30/G

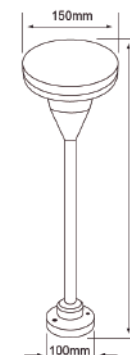
[Descargar Archivos](#)



 Piso	Gris	10 W	3000K	700 lm	100-240 VDC	80 IRC	 15.000h	106 Grado de Apertura	Aluminio Material Carcasa
---	-------------	----------------	--------------	------------------	----------------	------------------	---	---------------------------------	------------------------------





SPICA II
H-3423/BA

[Descargar Archivos](#)



44

IP

	Bronce		Aluminio
Piso		No lo incluye	Material Carcasa

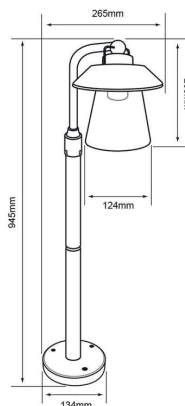

ALMODOVAR
H-410/S
H-410/N

[Descargar Archivos](#)



Ideal para Zonas Costeras

45

IP

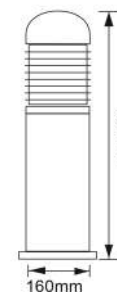

	Gris		Aluminio
Piso	Negro	No lo incluye	Material Carcasa

AMSTERDAM
H-430/S

[Descargar Archivos](#)



45

IP

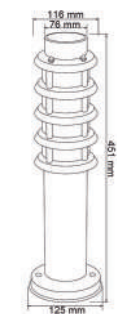

	Satinado		Lámina de Acero
Piso		No lo incluye	Material Carcasa



CINTAS

Led

LED 3528 SMD
MLED-60-IP45-127V/BC
MLED-60-IP45-127V/LD

[Descargar Archivos](#)

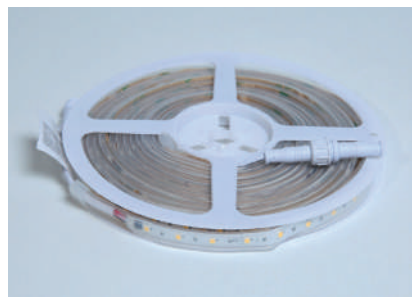

Primer y último corte a 25 cm.
Intermedios cada 50 cm.
(Ver zona de corte)
Crecimiento hasta 50 m

*NO REQUIERE DRIVER

5 METROS	8W/m 40W/5m W	3000K 6500K	364lm 336lm	127v	120 Grado de Apertura	30.000h	45 IP
-------------	---------------------	----------------	----------------	------	-----------------------------	---------	----------

LED 5050 SMD
MLED-60-IP45-5050-127V/BC
MLED-60-IP45-5050-127V/LD

[Descargar Archivos](#)



Corte cada 50 cm.
La unión debe soldarse
Crecimiento hasta 20 m

5 METROS	11W/m 55W/5m W	3000K 6500K	720.2lm 741.1lm	127v	120 Grado de Apertura	35.000h	45 IP
-------------	----------------------	----------------	--------------------	------	-----------------------------	---------	----------

ACCESORIOS

TLED-CON-H



Conector para conexiones en serie

Tiras:
3528SMD,
5050SMD,
2835SMD,
2216SMD

TLED-CON-T



Conector para conexiones en paralelo

Tiras:
3528SMD,
5050SMD,
2835SMD,
2216SMD

LED 5050 SMD
 MLED-5050SMD-127V/LD
 MLED-5050SMD-127V/BC

Descargar Archivos



*NO REQUIERE DRIVER



Intermedios cada 50 cm.
 (Ver zona de corte)
 Crecimiento hasta 50 m

5 METROS	11W/m 55W/5m W	3000K 6500K	720.2lm 741.1lm	127v	120 Grado de Apertura	35.000h
-------------	----------------------	----------------	--------------------	------	--------------------------	---------

ACCESORIOS

MLED-1-5050SMD



Cable con clavija para manguera de LED 5050 SMD

MLED-3-5050SMD



Conector medio para manguera de LED 5050 SMD

MLED-6-5050SMD



Tapa fin plástica para manguera de LED 5050 SMD

*Es responsabilidad del instalador aislar los conectores para su uso en exterior
 *Es necesario aislar con silicón y con cinta termocontractil las uniones entre cortes y/o acoplamientos para evitar filtración de agua.

LED 3528 SMD
 MLED-3528SMD-127V/BC
 MLED-3528SMD-127V/LD

[Descargar Archivos](#)



*NO REQUIERE DRIVER



Primer y último corte a 25 cm.
 Intermedios cada 50 cm.
 (Ver zona de corte)
 Crecimiento hasta 50 m

25 METROS	6W/m 150W/5m W	3000K 6500K	224lm 247lm	127v	120 Grado de Apertura	35.000h
--------------	----------------------	----------------	----------------	------	-----------------------------	---------

ACCESORIOS

MLED-1-SMD



Cable con clavija y conector de alta calidad para manguera de LED 3528 SMD

MLED-3-SMD



Conector medio de alta calidad para manguera de LED 3528 SMD

MLED-4-SMD



Conector en L de alta calidad para manguera de LED 3528 SMD (únicamente para cuadros)

MLED-6-SMD



Tapa fin plástica para manguera de LED SMD

*Es responsabilidad del instalador aislar los conectores para su uso en exterior
 *Es necesario aislar con silicón y con cinta termocontractil las uniones entre cortes y/o acoplamientos para evitar filtración de agua.



Regleta

REGLED-40W-RGBW

[Descargar Archivos](#)

IP
65

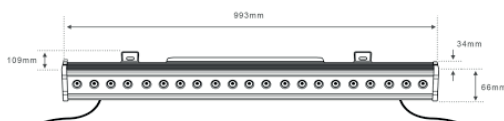

Negro	48 W	RGB	100-240 Voltaje	Aluminio Vidrio templado Material Carcasa
-------	---------	-----	--------------------	---





A warm, dimly lit bakery or cafe interior. The scene is filled with shelves of various pastries and breads. In the background, a person is visible, possibly a baker or server, working behind a counter. The lighting is soft and golden, creating a cozy atmosphere. The word "Bombillos" is written in a white, cursive font across the center of the image.

Bombillos



BOMBILLOS
Vintage

ADHAFERA
2DA19LEDFC20VA

[Descargar Archivos](#)



Ambar	2.3 W	2000K	60 lm	127 Voltaje	80 IRC	15.000h	300 Grado de Apertura
-------	----------	-------	----------	----------------	-----------	---------	--------------------------

VULPECULA
3DST64LEDFC20VA

[Descargar Archivos](#)



Ambar	2.3 W	2000K	120 lm	127 Voltaje	80 IRC	15.000h	300 Grado de Apertura
-------	----------	-------	-----------	----------------	-----------	---------	--------------------------

ALBIREO I
2DT30LEDFC20VA

[Descargar Archivos](#)



Ambar	2.3 W	2000K	60 lm	127 Voltaje	80 IRC	15.000h	300 Grado de Apertura
-------	----------	-------	----------	----------------	-----------	---------	--------------------------

ALBIREO II
3DT60LEDFC20VA

[Descargar Archivos](#)



Ambar	3.5 W	2000K	120 lm	127 Voltaje	80 IRC	15.000h	300 Grado de Apertura
-------	----------	-------	-----------	----------------	-----------	---------	--------------------------



AHIL
3DG125LEDFC20VA

[Descargar Archivos](#)



Ambar	3.5 W	2000K	120 lm	127 Voltaje	80 IRC	300 Grado de Apertura	15.000h
-------	----------	-------	-----------	----------------	-----------	--------------------------	---------

AHIL
3DG200LEDFC20VAH

[Descargar Archivos](#)



Ambar	3.5 W	2000K	120 lm	127 Voltaje	80 IRC	60 Grado de Apertura	15.000h
-------	----------	-------	-----------	----------------	-----------	-------------------------	---------

ACRAB
3DA165LEDFC20VA
[Descargar Archivos](#)

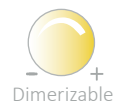

Dimerizable



ACRAB
3DA165LEDFC20VH
[Descargar Archivos](#)



Dimerizable



Ambar	3.5 W	2000K	120 lm	127 Voltaje	80 IRC	15.000h	300 Grado de Apertura
-------	----------	-------	-----------	----------------	-----------	---------	--------------------------

Humo	3.5 W	2000K	70 lm	127 Voltaje	80 IRC	15.000h	300 Grado de Apertura
------	----------	-------	----------	----------------	-----------	---------	--------------------------





AIN
3DG200LEDFC20VA
[Descargar Archivos](#)

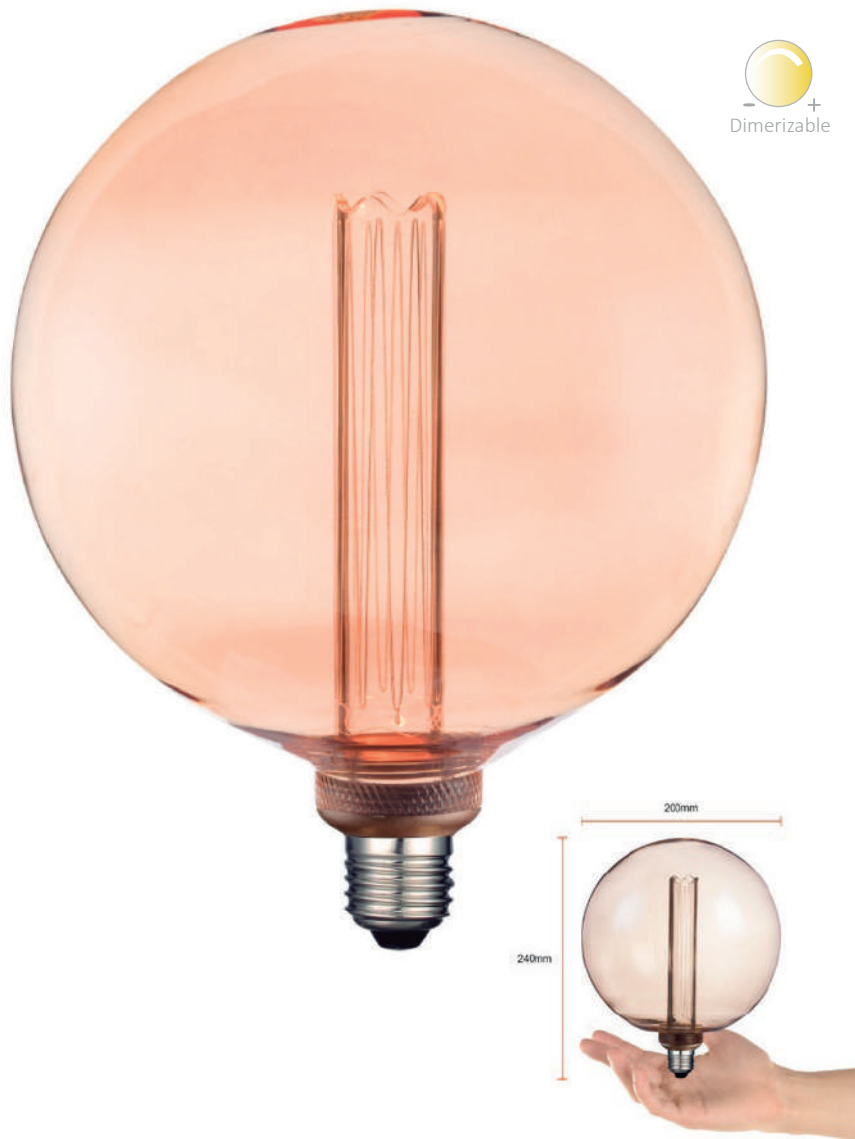

Ambar	3.5 W	2000K	120 lm	127 Voltaje	80 IRC	15.000h	300 Grado de Apertura
-------	----------	-------	-----------	----------------	-----------	---------	--------------------------

AIN
3DG200LEDFC20VH
[Descargar Archivos](#)

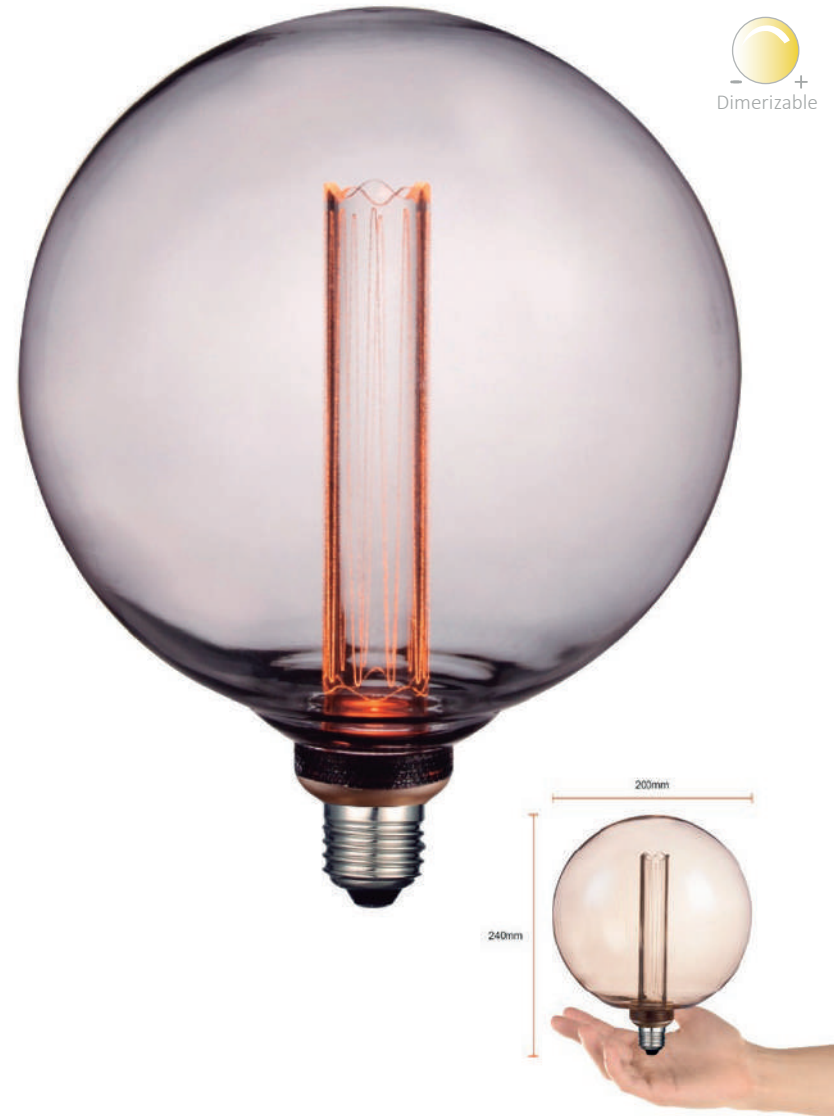

Humo	3.5 W	2000K	70 lm	127 Voltaje	80 IRC	15.000h	300 Grado de Apertura
------	----------	-------	----------	----------------	-----------	---------	--------------------------

ADHAFERA
7A19LEDF27V360

[Descargar Archivos](#)

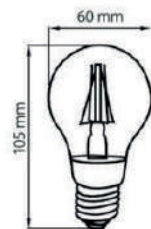

MERCURI II
A19D-LEDF/002/27

[Descargar Archivos](#)

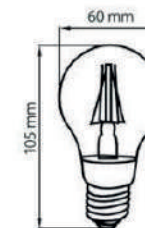

Transparente	7 W	2700K	700 lm	127 Voltaje	80 IRC	15.000h	360 Grado de Apertura
--------------	--------	-------	-----------	----------------	-----------	---------	--------------------------

GALLIUM II
FFE27D-LEDF001/27

[Descargar Archivos](#)



Transparente	4.5 W	2700K	420 lm	127 Voltaje	80 IRC	25.000h	360 Grado de Apertura
--------------	----------	-------	-----------	----------------	-----------	---------	--------------------------

Transparente	7 W	2700K	800 lm	127 Voltaje	80 IRC	15.000h	360 Grado de Apertura
--------------	--------	-------	-----------	----------------	-----------	---------	--------------------------

RADON I
G45D-LEDF/001/27

[Descargar Archivos](#)

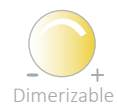

Transparente	4.5 W	2700K	420 lm	127 Voltaje	80 IRC	25.000h	150 Grado de Apertura
--------------	----------	-------	-----------	----------------	-----------	---------	--------------------------

RADON I
G45D-LEDF/001/27F

[Descargar Archivos](#)



Opalizado	4.5 W	2700K	420 lm	127 Voltaje	80 IRC	25.000h	150 Grado de Apertura
-----------	----------	-------	-----------	----------------	-----------	---------	--------------------------





SER-IP44-E27-24W-LEDS14

[Descargar Archivos](#)

Uso con todo tipo de lámparas
incandescentes, fluorescentes y Led

Longitud de cable
15.85 cms



Incluye 24 Lámparas
LED de 1W

Serie 24 lámparas LED base E27

Transparente	15.85 METROS	2700K	1 W	127 Voltaje
--------------	-----------------	-------	--------	----------------

197

S14/LED/1W/127V/2200K

[Descargar Archivos](#)

Presentación
en Blister

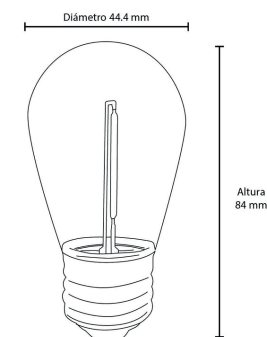

Transparente	1 W	50 lm	2200K	127 Voltaje
--------------	--------	----------	-------	----------------

A collage of various light bulbs hanging from black cords against a background of vertical blinds and greenery. The bulbs are in different stages of being lit, with some glowing warmly and others unlit. The scene is split vertically, with the left side being more brightly lit and the right side being darker, suggesting a window view of the outdoors.

PORTA
Lâmparas

60SOCK106MVE27N

[Descargar Archivos](#)

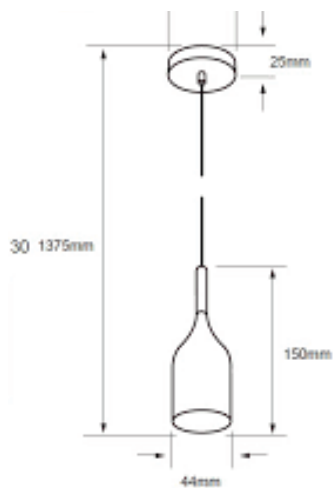

60SOCK044MVE27N

[Descargar Archivos](#)

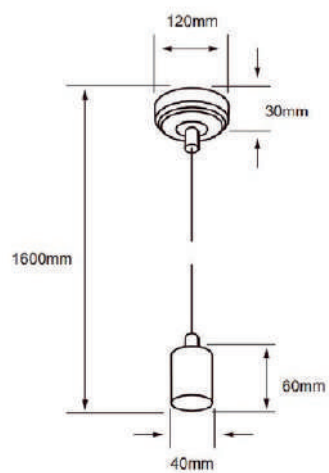

60SOCK055MVE27HA

[Descargar Archivos](#)

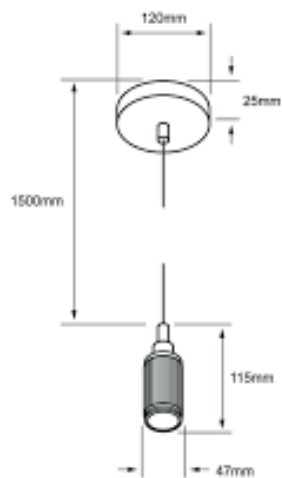



60SOCK110MVE27HA

[Descargar Archivos](#)

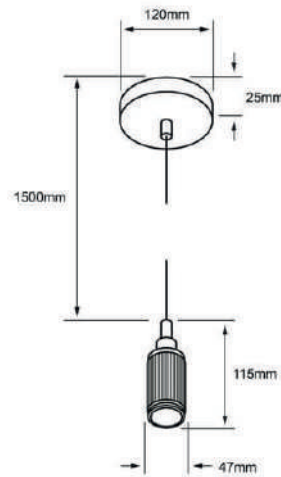

60SOCK111MVE27HA

[Descargar Archivos](#)

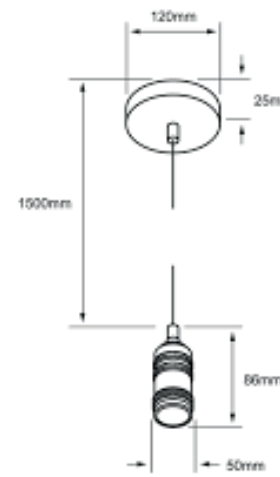

60SOCK112MVE27O

[Descargar Archivos](#)

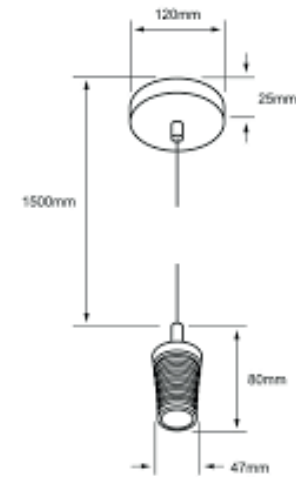
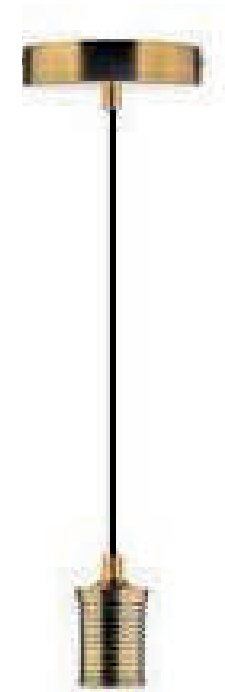

60SOCK113MVE27S

[Descargar Archivos](#)

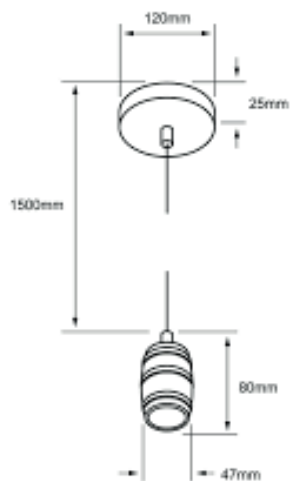
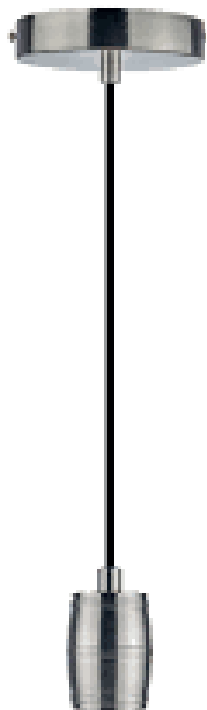

60SOCK114MVE27N

[Descargar Archivos](#)

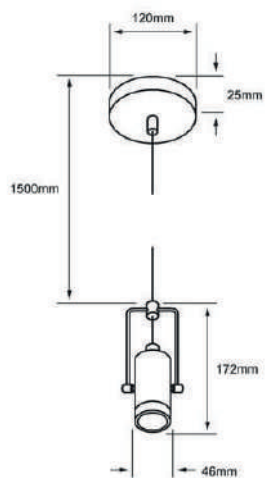

60SOCK115MVE27S

[Descargar Archivos](#)

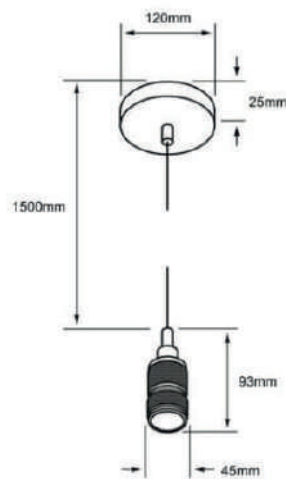

Iluminación Luz Cálida



Iluminación con Bombillo MOON LIGHT

6GU10LEDLLVEMV35

[Descargar Archivos](#)



LUZ VERDE



Negro	6 W		100-277 Voltaje	80 IRC	 15.000h	35 Grado de Apertura
-------	--------	--	--------------------	-----------	-------------	-------------------------

16PAR38LEDLLVEMV35

[Descargar Archivos](#)



Negro	16 W		100-277 Voltaje	80 IRC	 15.000h	35 Grado de Apertura
-------	---------	--	--------------------	-----------	-------------	-------------------------

TITANIUM V
A19-LED/005/30
A19-LED/005/65

[Descargar Archivos](#)



Blanco	14 W	3000K 6500K	1300 lm	100-240 Voltaje	80 IRC	15.000h	220 Grado de Apertura
--------	---------	----------------	------------	--------------------	-----------	---------	--------------------------

TITANIUM V
17A19LED30MV270
17A19LED65MV270

[Descargar Archivos](#)



Blanco	17 W	3000K 6500K	1500 lm	100-240 Voltaje	80 IRC	15.000h	270 Grado de Apertura
--------	---------	----------------	------------	--------------------	-----------	---------	--------------------------

HIDRUS I
A19-LED/010/30
A19-LED/010/65

[Descargar Archivos](#)



Blanco	8.5 W	3000K 6500K	800 lm	100-240 Voltaje	80 IRC	15.000h	220 Grado de Apertura
--------	----------	----------------	-----------	--------------------	-----------	---------	--------------------------

CANES III
A19-LED/012/30
A19-LED/012/65

[Descargar Archivos](#)



Blanco	11 W	3000K 6500K	1000 lm	100-240 Voltaje	80 IRC	15.000h	220 Grado de Apertura
--------	---------	----------------	------------	--------------------	-----------	---------	--------------------------





PYXIES IV
 GU10L-LED/001/30
 6GU10LLED40MV36
 GU10L-LED/001/65

[Descargar Archivos](#)
[Descargar Archivos](#)



Blanco	6 W	3000K 4000K 6500K	550 lm	100-240 Voltaje	80 IRC	15.000h	36 Grado de Apertura
--------	--------	-------------------------	-----------	--------------------	-----------	---------	-------------------------

RADIUM III
 GU10D-LED/001/30
 GU10D-LED/001/40

[Descargar Archivos](#)



Dimerizable



Blanco	7 w	3000K 4000K	600 lm	100-240 Voltaje	80 IRC	25.000h	40 Grado de Apertura
--------	--------	----------------	-----------	--------------------	-----------	---------	-------------------------



HELIUM I
15DAR111LED30V12

[Descargar Archivos](#)



Dimerizable

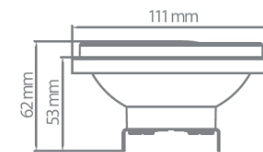

Cromo	15 W	3000K	1200 lm	100-127 Voltaje	80 IRC	15.000h	8 Grado de Apertura
-------	---------	-------	------------	--------------------	-----------	---------	------------------------

HELIUM II
15DAR111LED30V24
15DAR111LED40V24

[Descargar Archivos](#)



Dimerizable

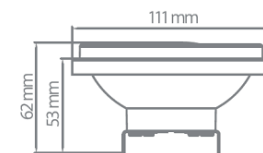

Cromo	15 W	3000K 4000K	1350 lm	100-127 Voltaje	80 IRC	15.000h	24 Grado de Apertura
-------	---------	----------------	------------	--------------------	-----------	---------	-------------------------

CORVUS I
6PAR20LED30MV25
6PAR20LED65MV25

[Descargar Archivos](#)

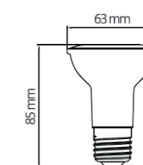

Blanco	6 W	3000K 6500K	500 lm	100-240 Voltaje	80 IRC	25.000h	25 Grado de Apertura
--------	--------	----------------	-----------	--------------------	-----------	---------	-------------------------

207

CORVUS III
7DPAR20LED30V40

[Descargar Archivos](#)

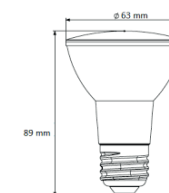

Blanco	7 W	3000K	500 lm	127 Voltaje	80 IRC	25.000h	40 Grado de Apertura
--------	--------	-------	-----------	----------------	-----------	---------	-------------------------



PEGASUS I
8PAR30LED30MV25
8PAR30LED40MV25
8PAR30LED65MV25

[Descargar Archivos](#)



Blanco	8.5 W	3000K 4000K 6500K	850 lm	100-240 Voltaje	80 IRC	25.000h	25 Grado de Apertura
--------	----------	-------------------------	-----------	--------------------	-----------	---------	-------------------------

PEGASUS I
8PAR30LED30MV25N

[Descargar Archivos](#)



Negro	8.5 W	3000K	850 lm	100-240 Voltaje	80 IRC	25.000h	25 Grado de Apertura
-------	----------	-------	-----------	--------------------	-----------	---------	-------------------------

PEGASUS III
10DPAR30LED30V40

[Descargar Archivos](#)



Dimerizable



Blanco	10 W	3000K	800 lm	100-240 Voltaje	80 IRC	25.000h	40 Grado de Apertura
--------	---------	-------	-----------	--------------------	-----------	---------	-------------------------

AQUILA
13PAR38LED30MV25
13PAR38LED65MV25

[Descargar Archivos](#)



Blanco	13 W	3000K 6500K	1250 lm	100-240 Voltaje	80 IRC	25.000h	25 Grado de Apertura
--------	---------	----------------	------------	--------------------	-----------	---------	-------------------------

ORION VI
15DPAR38LED30V40

[Descargar Archivos](#)



Blanco	15 W	3000K	1200 lm	127 Voltaje	80 IRC	25.000h	40 Grado de Apertura
--------	---------	-------	------------	----------------	-----------	---------	-------------------------

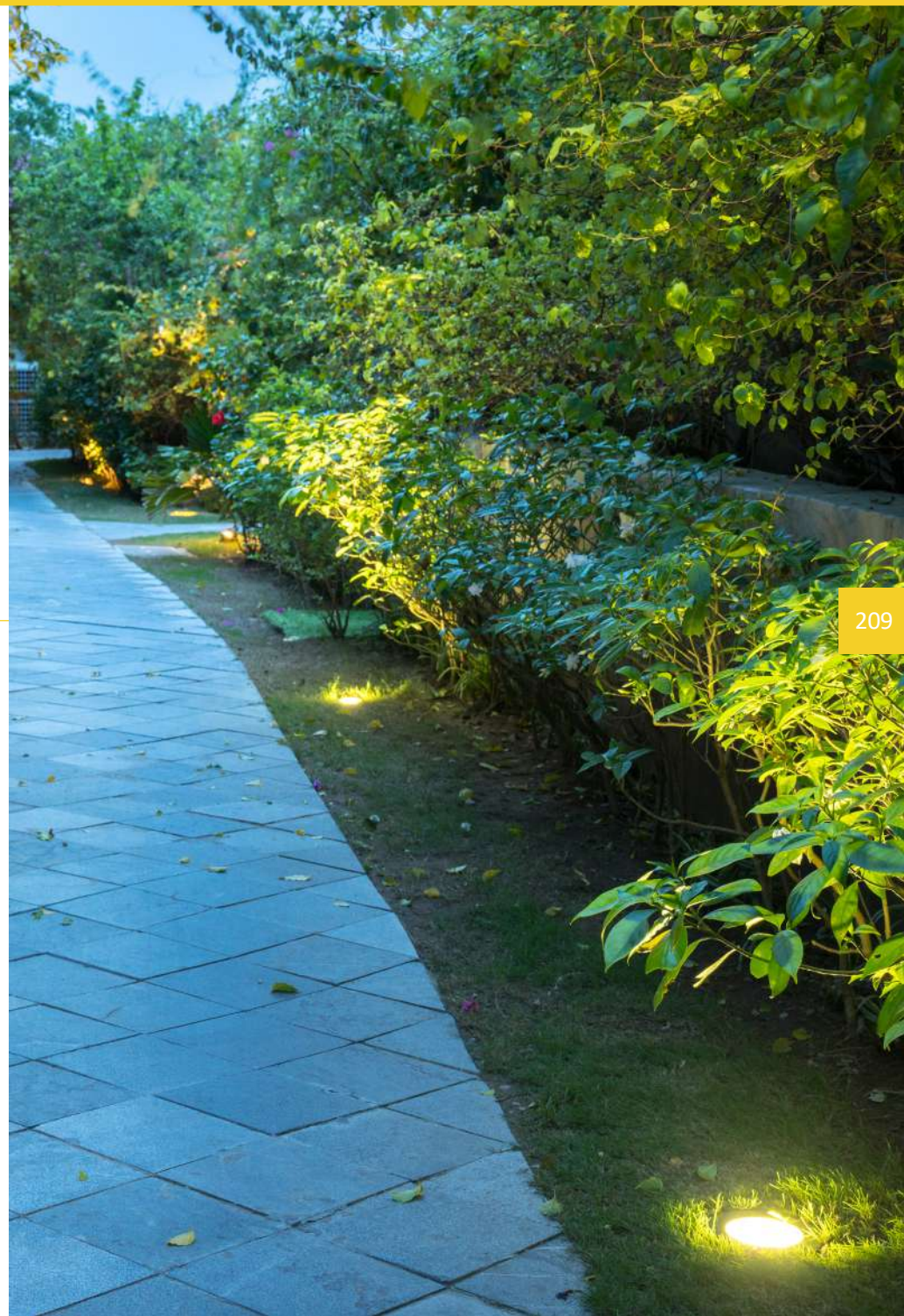

20LHLEDT65MV200

[Descargar Archivos](#)

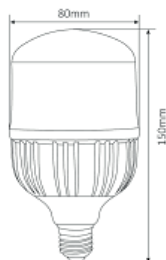

Blanco	20 W	6500K	1800 lm	100-240 Voltaje	80 IRC	25.000h	200 Grado de Apertura
--------	---------	-------	------------	--------------------	-----------	---------	--------------------------

210

30LHLEDT65MV200

[Descargar Archivos](#)

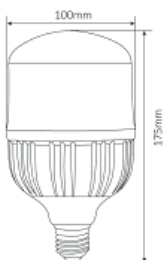

Blanco	30 W	6500K	2700 lm	100-240 Voltaje	80 IRC	25.000h	200 Grado de Apertura
--------	---------	-------	------------	--------------------	-----------	---------	--------------------------

50LHLEDT65MV200

[Descargar Archivos](#)

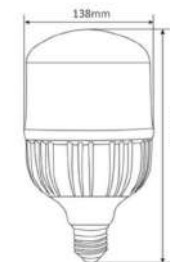

Blanco	50 W	6500K	4500 lm	100-240 Voltaje	80 IRC	25.000h	200 Grado de Apertura
--------	---------	-------	------------	--------------------	-----------	---------	--------------------------

OGMA III
09T8LED60MV65C

[Descargar Archivos](#)

60 cms



Multivoltaje

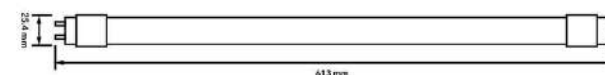

Blanco	9 w	6500K	800 lm	100-277 Voltaje	80 IRC	20.000h	210 Grado de Apertura
--------	--------	-------	-----------	--------------------	-----------	---------	--------------------------

OGMA IV
18T8LED120MV40C
18T8LED120MV65C
18T8LED120MV65CT

[Descargar Archivos](#)

120 cms



Multivoltaje

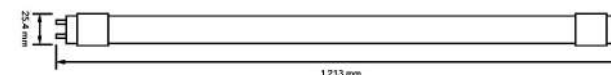

Blanco	18 w	4000K 6500K	1600 lm	100-277 Voltaje	70 IRC	20.000h	210 Grado de Apertura
--------	---------	----------------	------------	--------------------	-----------	---------	--------------------------

TABLA CLASIFICACIÓN IP

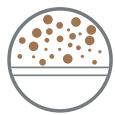

6

Totalmente protegido contra polvo.
Totalmente sellado

+



5

No debe entrar el agua arrojada a chorro (desde cualquier ángulo) por medio de una boquilla de 6,3 mm de diámetro, a un promedio de 12,5 litros por minuto y a una presión 30 km/m² durante un tiempo que no sea menor a 3 minutos y a una distancia que no sea menor a 3 metros.

ZONA 2 IP44 / IP45 / IP54 :
Luminarios en muro

Se requiere que se encuentren en lugares techados.

ZONA 5 IP68 :
Luminarios de piscinas/estanques

La máxima protección posible y diseñadas para su instalación sumergidas.

ZONA 4 IP67 :
Luminarios al borde de piscinas o estanques

Luminarias protegidas al máximo contra la acción del polvo y preparadas para inmersiones de agua temporales.

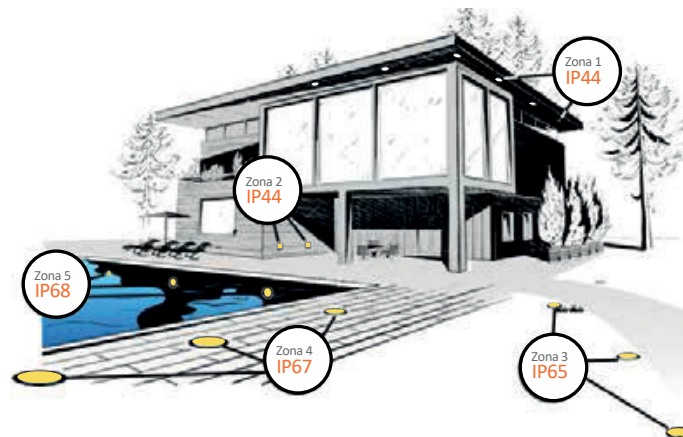

1er DIGITO: Objetos Grado de protección resistente a objetos Sólidos

	Sin protección.	0
	Protección contra objetos sólidos de más de 50 mm. (Contacto involuntario de las manos)	1
	Protección contra objetos sólidos de más de 12 mm. (Contacto con los dedos)	2
	Protección contra objetos sólidos de más de 2.5 mm. (Herramientas y cables)	3
	Protección contra objetos sólidos de más de 1 mm. (Herramientas y pequeños cables)	4
	Protección contra ingreso limitado de polvo. (No incluye materiales peligrosos)	5
	Totalmente protegido contra polvo. Totalmente sellado.	6

2º DIGITO: Líquidos Grado de protección resistente al agua

	Sin protección.	0
	No debe entrar el agua cuando se la deja caer, desde 200mm de altura respecto del equipo, durante 10 minutos (a razón de 3-5mm ³ por minuto).	1
	No debe entrar el agua cuando se la deja caer, durante 10 minutos (a razón de 3-5mm ³ por minuto). Dicha prueba se realizará 4 veces a razón de una por cada giro de 15º tanto en sentido vertical como horizontal, partiendo cada vez de la posición normal de trabajo.	2
	No debe entrar el agua nebulizada en un ángulo de hasta 60º a derecha e izquierda de la vertical a un promedio de 11 litros por minuto y a una presión de 800-100 km/m ² durante un tiempo que no sea menor a 5 minutos.	3
	No debe entrar el agua arrojada desde cualquier ángulo a un promedio de 10 litros por minuto y a una presión de 800-100 km/m ² durante un tiempo que no sea menor a 5 minutos.	4
	No debe entrar el agua arrojada a chorro (desde cualquier ángulo) por medio de una boquilla de 6,3 mm de diámetro, a un promedio de 12,5 litros por minuto y a una presión 30 km/m ² durante un tiempo que no sea menor a 3 minutos y a una distancia que no sea menor de 3 metros.	5
	No debe entrar el agua arrojada a chorros (desde cualquier ángulo) por medio de una boquilla de 12,5 mm de diámetro, a un promedio de 100 litros por minuto y a una presión 100 km/m ² durante un tiempo que no sea menor a 3 minutos y a una distancia que no sea menor de 3 metros.	6
	El equipo debe soportar sin filtración alguna la inmersión completa a 1 metro durante 30 minutos.	7
	El equipo debe soportar sin filtración alguna la inmersión completa y continua a la profundidad y durante el tiempo que especifique el fabricante del producto con el acuerdo del cliente, pero siempre que resulten condiciones más severas que las especificadas para el valor 7.	8

ZONA 1 IP44 / IP45 / IP54 :
Luminarios bajo techo

Se requiere que estén en lugares techados, ejemplo: una marquesina. Están protegidos contra salpicaduras de gotas.

ZONA 3 IP65 :
Luminarios empotrados en jardín



Este tipo de luminarias cuentan con la máxima protección contra la acción del polvo y agua.

A modern interior space featuring wood-paneled walls with recessed linear lighting. In the foreground, there is a light-colored coffee table with a reed diffuser on a tray. To the right, there is a brown leather sofa and a matching armchair. A vase with white flowers sits on a surface in the background.

tecnolite[®]

ILUMINACIÓN

www.tecnolite.lat

   [tecnolitecolombia](#)